

HEARTH CRAFT



SUGGESTED RETAIL PRICING

Effective May 31st, 2012

BENEFITS OF HAVING A FIREPLACE DOOR

Reduce Down Drafts- When the fireplace is cool and not in use, by closing the fireplace doors, you will substantially reduce the amount of down draft through the opening. The problem of down drafts is more pronounced in more tightly insulated newer homes when exhaust fans in the bathroom or kitchen are turned on.

Prevent Heat Loss-Save Energy As the fire is dying down, and before the fireplace is cooled off, for a period of time warm room air continues to flow up the flue to the outdoors. By closing the fireplace door at this time, you will substantially reduce the amount of heat loss to the outdoors.

Smoke Spillage- If for any reason you experience smoke spillage to the inside of the room, by closing the glass doors, you will substantially reduce the amount of smoke spillage.

Odor Containment- Cord wood burning fireplaces in particular may have a certain odor, which will be less pronounced if glass doors are in closed position.

Aesthetics- The fireplace almost always occupies a prominent, or focal point in a room. The fireplace enclosure will give you the ability to give your fireplace a finished look and is a decorating tool.

Safety- By closing the fireplace door as the fire is dying down, you will have enhanced spark protection, and greatly reduces the chance of causing an unintended fire in case of possible re-ignition.

CHOOSING THE RIGHT DOOR

Hearth Craft makes fireplace doors for masonry as well as zero clearance fireplaces. The first step would be to verify what type of fireplace you have.

Masonry Fireplace: These are made of brick and mortar, and burn either cordwood or artificial log sets. These units take combustion air from the dwelling and vent products of combustion outside the dwelling, normally vented up through the roof of a structure. You can choose any of our masonry glass doors for this type of fireplace.

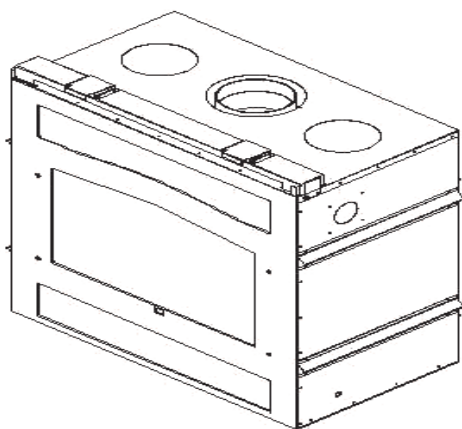
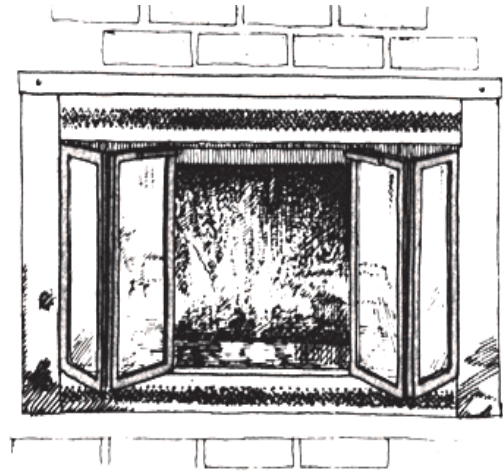

Prefabricated (zero-clearance) Fireplace:

This is a factory built fireplace that can be safely built into a wall or a corner. There are many different type of zero-clearance fireplaces. Our Rainbow zero-clearance doors can be used only on factory built fireplaces that burn either cordwood or artificial log sets, and use factory-built metal pipes that take in combustion air

from the dwelling and vent products of combustion outside the dwelling through the roof. Do not install Hearth Craft glass enclosures on vent-free fireboxes.

How to Measure for a Fireplace Door

Prior to ordering, door size must be determined. For all masonry doors, please use the guidelines below to determine door size, then use the door size to determine the stock number and pricing. For Rainbow Doors, please use the work sheets provided.

For the best fit, the fireplace opening should meet the following requirements:

- Mounting surface should be smooth and level.
- Suitable mounting surface on top and bottom of opening.
- Fireplace opening should be square & level.
- Any out of plumb conditions on the opening will be exaggerated or will prevent installation or proper operation of door.
- If measurements do not correspond to a stock size, a custom door will need to be ordered.

Measuring the Fireplace Opening (Example)

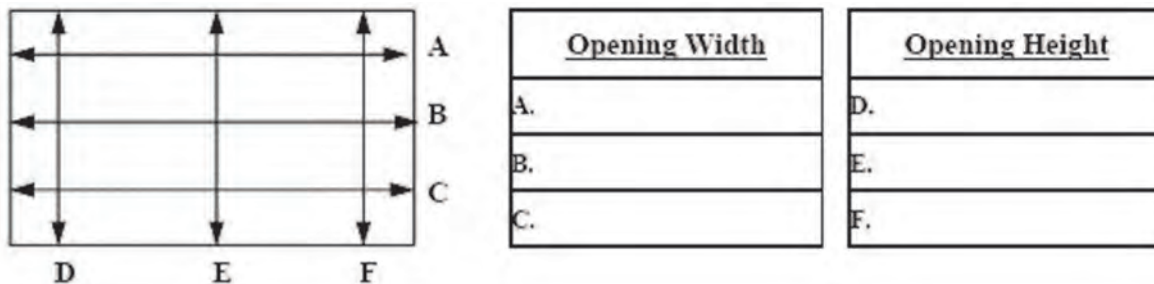

- You will need to measure the fireplace opening in three different places, both vertically and horizontally.
- Measure the inside of the fireplace opening to the nearest **1/16"**.
- Write down the measurements.
- Using the **smallest opening dimensions**, refer to sizing charts given on the Product Information pages to determine door size.
- If measurements do not correspond with opening sizes on the chart, we can make a custom door for you.

How to Order

STEP 1

REVIEW PRODUCT PAGES & SELECT A MODEL

STEP 2

USE THE SIZING CHARTS (EXAMPLE SHOWN BELOW)
TO DETERMINE DOOR SIZE

Door Size	Opening Width	Opening Height	Finished Dimensions of Door
3425	27 1/8 To 33"	20 5/8 To 24 1/2"	34 x 25"
3429	27 1/8 To 33"	24 5/8 To 28 1/2"	34 x 29"
4025	33 1/8 To 39"	20 5/8 To 24 1/2"	40 x 25"
4029	33 1/8 To 39"	24 5/8 To 28 1/2"	40 x 29"
4033	33 1/8 To 39"	28 5/8 To 32 1/2"	40 x 33"
4625	39 1/8 To 45"	20 5/8 To 24 1/2"	46 x 25"
4629	39 1/8 To 45"	24 5/8 To 28 1/2"	46 x 29"
4633	39 1/8 To 45"	28 5/8 To 32 1/2"	46 x 33"

STEP 3

USE THE DOOR SIZE DETERMINED ABOVE TO FIND THE
STOCK NUMBER, FINISH AND PRICE (EXAMPLE GIVEN BELOW)

Plated Polished Brass

Size	Stock No.	Sugg. Retail Price
3425	04710F	\$419.00
3429	04711F	\$419.00
4025	04712F	\$429.00
4029	04713F	\$429.00
4033	04714F	\$429.00
4625	04715F	\$439.00
4629	04716F	\$439.00
4633	04717F	\$439.00

STEP 4

SPECIAL OPTIONS VARY FROM DOOR TO DOOR.
PLEASE BE SURE TO SPECIFY COLOR OF GLASS &
TRIM FINISH ON PURCHASE ORDER.

Special Options

Cabinet Door Set	\$30.00 Net
Bronze or Gray Glass	\$30.00 Net
Different Trim Finish	\$30.00 Net
Beveled Glass	\$125.00 Net
Please allow 4 weeks for beveled glass.	

STEP 5

DOUBLE CHECK ALL YOUR INFORMATION !

BEFORE ORDERING, BE SURE TO MAKE NOTE ON PURCHASE ORDER OF ANY SPECIAL OPTIONS TO BE ADDED. PLEASE KEEP IN MIND THAT SPECIAL OPTIONS ADDED TO ANY STOCK DOOR WILL TAKE UP TO TEN BUSINESS DAYS TO COMPLETE. HEARTH EXPRESS COSTS ARE AN ADDITIONAL \$30 (NET) FOR NON STOCKED ITEMS & RAINBOWS, \$60 (NET) FOR CUSTOM MASONRY DOORS (PER DOOR). WE WILL EXPIDITE "HEARTH EXPRESS" ORDERS TO BE COMPLETED WITHIN 7 BUSINESS DAYS (NOT AVAILABLE FOR BEVEL GLASS ORDERS). MISSING INFORMATION WILL CAUSE A DELAY IN YOUR ORDER, SO PLEASE BE SURE ALL THE INFORMATION IS CORRECT. ACKNOWLEDGEMENTS WILL BE FAXED WITHIN 24-48 (BUSINESS) HOURS OF RECIEPT.

Slimline



Masonry doors overlap the fireplace opening and require a suitable, smooth and level mounting surface for installation. Please measure the opening dimensions of your fireplace and refer to the sizing chart on this page to determine the proper size you will need to order.

Features:

- Trimless full - fold doors open 180 degrees for enhanced viewing, ease of cleaning, and safety.
- Comes standard with 3/16" inch clear tempered and edged glass and mesh curtain.
- Constructed of a 3" wide by 1" deep frame.
- Damper Control.

Available finishes are:

Antique Brass, Polished Brass, Flat Black and Flat Black frame and Polished Brass door set and Satin Nickel.

Sizing Chart

Door Size	Opening Width	Opening Height	Finished Dimensions of Door
3425	27 1/8 To 33"	20 5/8 To 24 1/2"	34 x 25"
3429	27 1/8 To 33"	24 5/8 To 28 1/2"	34 x 29"
4025	33 1/8 To 39"	20 5/8 To 24 1/2"	40 x 25"
4029	33 1/8 To 39"	24 5/8 To 28 1/2"	40 x 29"
4033	33 1/8 To 39"	28 5/8 To 32 1/2"	40 x 33"
4625	39 1/8 To 45"	20 5/8 To 24 1/2"	46 x 25"
4629	39 1/8 To 45"	24 5/8 To 28 1/2"	46 x 29"
4633	39 1/8 To 45"	28 5/8 To 32 1/2"	46 x 33"

Stock Numbers and Suggested Retail Pricing

Every effort is made to keep "Stock" doors indicated in Bold letters available for immediate shipment. All others will ship within 10 to 15 business days. Stock doors with special options such as glass color change will ship in 10 to 15 business days. For an additional \$30 (net), non-stock items will be shipped within seven business days by placing "Hearth Express" on your faxed order.

Plated Antique Brass

Size	Stock No.	Retail Price
3425	04410F	\$419.00
3429	04411F	\$419.00
4025	04412F	\$429.00
4029	04413F	\$429.00
4033	04414F	\$429.00
4625	04415F	\$439.00
4629	04416F	\$439.00
4633	04417F	\$439.00

Plated Polished Brass

Size	Stock No.	Retail Price
3425	04710F	\$419.00
3429	04711F	\$419.00
4025	04712F	\$429.00
4029	04713F	\$429.00
4033	04714F	\$429.00
4625	04715F	\$439.00
4629	04716F	\$439.00
4633	04717F	\$439.00

Flat Black

Size	Stock No.	Retail Price
3425	04310F	\$429.00
3429	04311F	\$429.00
4025	04312F	\$439.00
4029	04313F	\$439.00
4033	04314F	\$439.00
4625	04315F	\$449.00
4629	04316F	\$449.00
4633	04317F	\$449.00

Flat Black & Polished Brass

Size	Stock No.	Retail Price
3425	04210F	\$429.00
3429	04211F	\$429.00
4025	04212F	\$439.00
4029	04213F	\$439.00
4033	04214F	\$439.00
4625	04215F	\$449.00
4629	04216F	\$449.00
4633	04217F	\$449.00

Satin Nickel

Size	Stock No.	Retail Price
3425	04910F	\$429.00
3429	04911F	\$429.00
4025	04912F	\$439.00
4029	04913F	\$439.00
4033	04914F	\$439.00
4625	04915F	\$449.00
4629	04916F	\$449.00
4633	04917F	\$449.00

Special Options

Cabinet Door Set	\$30.00 Net
Bronze or Gray Glass	\$30.00 Net
Different Trim Finish	\$30.00 Net
Beveled Glass	\$125.00 Net

Sentry Premiere

Full-Fold

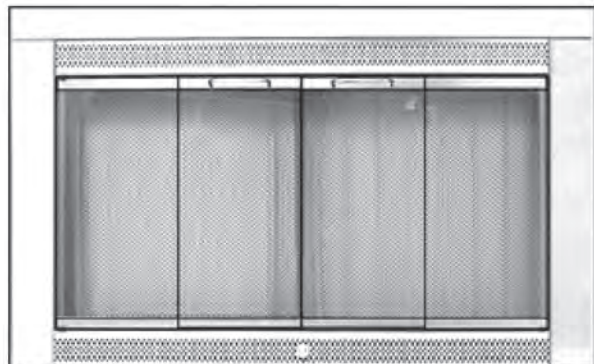

Masonry doors overlap the fireplace opening and require a suitable, smooth and level mounting surface for installation. Please measure the opening dimensions of your fireplace and refer to the sizing chart on this page to determine the proper size you will need to order.

Features:

- Trimless full - fold doors open 180 degrees for enhanced viewing, ease of cleaning, and safety.
- Comes standard with 3/16" inch clear tempered and edged glass and mesh curtain.
- Constructed of a 3" wide x 1-1/2" deep frame.
- Dual filigree pattern at top and bottom, with single, lower, damper control.

Available finishes are:

Antique Brass, Polished Brass, Flat Black, Flat Black frame and Polished Brass door set trim and Satin Nickel.

Sizing Chart

Door Size	Opening Width	Opening Height	Finished Dimensions of Door
3425	27 1/8 To 33"	20 5/8 To 24 1/2"	34 1/8 x 25"
3429	27 1/8 To 33"	24 5/8 To 28 1/2"	34 1/8 x 29"
4025	33 1/8 To 39"	20 5/8 To 24 1/2"	40 1/8 x 25"
4029	33 1/8 To 39"	24 5/8 To 28 1/2"	40 1/8 x 29"
4033	33 1/8 To 39"	28 5/8 To 32 1/2"	40 1/8 x 33"
4625	39 1/8 To 45"	20 5/8 To 24 1/2"	46 1/8 x 25"
4629	39 1/8 To 45"	24 5/8 To 28 1/2"	46 1/8 x 29"
4633	39 1/8 To 45"	28 5/8 To 32 1/2"	46 1/8 x 33"
5229	45 1/8 To 51"	24 5/8 To 28 1/2"	52 1/8 x 29"
5233	45 1/8 To 51"	28 5/8 To 32 1/2"	52 1/8 x 33"

Stock Numbers and Suggested Retail Pricing

Every effort is made to keep "Stock" doors indicated in Bold letters available for immediate shipment. All others will ship within 10 to 15 business days. Stock doors with special options such as glass color change will ship in 10 to 15 business days. For an additional \$30 (net), non-stock items will be shipped within seven business days by placing "Hearth Express" on your faxed order.

Plated Antique Brass

Size	Stock No.	Retail Price
3425	16900F	\$519.00
3429	16901F	\$519.00
4025	16902F	\$529.00
4029	16903F	\$529.00
4033	16904F	\$529.00
4625	16905F	\$539.00
4629	16906F	\$539.00
4633	16907F	\$539.00
5229	16908F	\$549.00
5233	16909F	\$549.00

Plated Polished Brass

Size	Stock No.	Retail Price
3425	16910F	\$519.00
3429	16911F	\$519.00
4025	16912F	\$529.00
4029	16913F	\$529.00
4033	16914F	\$529.00
4625	16915F	\$539.00
4629	16916F	\$539.00
4633	16917F	\$539.00
5229	16918F	\$549.00
5233	16919F	\$549.00

Flat Black

Size	Stock No.	Retail Price
3425	16930F	\$529.00
3429	16931F	\$529.00
4025	16932F	\$539.00
4029	16933F	\$539.00
4033	16934F	\$539.00
4625	16935F	\$549.00
4629	16936F	\$549.00
4633	16937F	\$549.00
5229	16938F	\$559.00
5233	16939F	\$559.00

Flat Black & Polished Brass

Size	Stock No.	Retail Price
3425	16920F	\$529.00
3429	16921F	\$529.00
4025	16922F	\$539.00
4029	16923F	\$539.00
4033	16924F	\$539.00
4625	16925F	\$549.00
4629	16926F	\$549.00
4633	16927F	\$549.00
5229	16928F	\$559.00
5233	16929F	\$559.00

Satin Nickel

Size	Stock No.	Retail Price
3425	16950F	\$529.00
3429	16951F	\$529.00
4025	16952F	\$539.00
4029	16953F	\$539.00
4033	16954F	\$539.00
4625	16955F	\$549.00
4629	16956F	\$549.00
4633	16957F	\$549.00
5229	16958F	\$559.00
5233	16959F	\$559.00

Special Options

Cabinet Door Set	\$30.00 Net
Bronze or Gray Glass	\$30.00 Net
Different Trim Finish	\$30.00 Net
Beveled Glass	\$125.00 Net

2” Riser Bars



Hearth Craft’s Riser Bars add 2” height to all **Sentry, Classic, Contemporary & Traditional Series doors.**

Custom lengths are also available for an Additional \$20.00 Set-Up Charge (no discounts). Please allow up to ten business days for custom sizes.

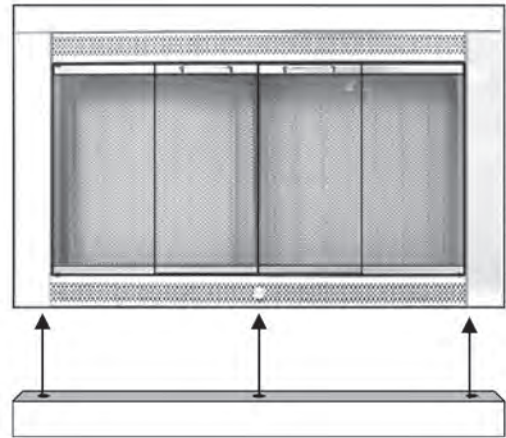

2” Riser Bars attached easily to the bottom of the doors. For Example, adding a riser bar to a door size of 4029 will then change the size to 4031.

Riser Bars are not intended for the Slimline, Ultraview, Mystique, Horizon or Rainbow Series.

Plated Antique Brass

Size	Stock No.	Retail Price
34"	34040	\$40.00
40"	40040	\$45.00
46"	46040	\$50.00
52"	52040	\$55.00

Plated Polished Brass

Size	Stock No.	Retail Price
34"	34030	\$40.00
40"	40030	\$45.00
46"	46030	\$50.00
52"	52030	\$55.00

Flat Black

Size	Stock No.	Retail Price
34"	34010	\$45.00
40"	40010	\$50.00
46"	46010	\$55.00
52"	52010	\$60.00

Satin Nickel

Size	Stock No.	Retail Price
34"	34050	\$45.00
40"	40050	\$50.00
46"	46050	\$55.00
52"	52050	\$60.00

Ultraview

Masonry doors overlap the fireplace opening and require a suitable and smooth and level mounting surface for installation. Please measure the opening dimensions of your fireplace and refer to the sizing chart on this page to determine the proper size you will need to order. 17



Features:

- Trimless full fold doors open 180 degrees for enhanced viewing, ease of cleaning, and safety.
- Comes standard with 3/16" inch bronze, tempered and edged glass and mesh curtains.
- 1 3/4" wide by 1" deep, steel-reinforced frame .

Available finishes are:

Antique Brass, Polished Brass, Flat Black, Flat Black frame and Polished Brass door set trim, Satin Nickel, Vintage Iron and Antique Bronze .

Sizing Chart

Door Size	Opening Width	Opening Height	Finished Dimensions of Door
3825	33 1/8 To 37"	22 5/8 To 24 1/2"	38 x 25 1/16"
3827	33 1/8 To 37"	24 5/8 To 26 1/2"	38 x 27 1/16"
3829	33 1/8 To 37"	26 5/8 To 28 1/2"	38 x 29 1/16"
3831	33 1/8 To 37"	28 5/8 To 30 1/2"	38 x 31 1/16"
3833	33 1/8 To 37"	30 5/8 To 32 1/2"	38 x 33 1/16"
4225	37 1/8 To 41"	22 5/8 To 24 1/2"	42 x 25 1/16"
4227	37 1/8 To 41"	24 5/8 To 26 1/2"	42 x 27 1/16"
4229	37 1/8 To 41"	26 5/8 To 28 1/2"	42 x 29 1/16"
4231	37 1/8 To 41"	28 5/8 To 30 1/2"	42 x 31 1/16"
4233	37 1/8 To 41"	30 5/8 To 32 1/2"	42 x 33 1/16"
4625	41 1/8 To 45"	22 5/8 To 24 1/2"	46 x 25 1/16"
4627	41 1/8 To 45"	24 5/8 To 26 1/2"	46 x 27 1/16"
4629	41 1/8 To 45"	26 5/8 To 28 1/2"	46 x 29 1/16"
4631	41 1/8 To 45"	28 5/8 To 30 1/2"	46 x 31 1/16"
4633	41 1/8 To 45"	30 5/8 To 32 1/2"	46 x 33 1/16"

Stock Numbers and Suggested Retail Pricing

Every effort is made to keep "Stock" doors indicated in Bold letters available for immediate shipment. All others will ship within 10 to 15 business days. Stock doors with special options such as glass color change will ship in 10 to 15 business days. For an additional \$30 (net), non-stock items will be shipped within seven business days by placing "Hearth Express" on your faxed order.

<u>Plated Antique Brass</u>			<u>Plated Polished Brass</u>			<u>Flat Black</u>		
Size	Stock No.	Retail Price	Size	Stock No.	Retail Price	Size	Stock No.	Retail Price
3825	938250	\$629.00	3825	938251	\$629.00	3825	938252	\$639.00
3827	938270	\$629.00	3827	938271	\$629.00	3827	938272	\$639.00
3829	938290	\$629.00	3829	938291	\$629.00	3829	938292	\$639.00
3831	938310	\$649.00	3831	938311	\$649.00	3831	938312	\$659.00
3833	938330	\$649.00	3833	938331	\$649.00	3833	938332	\$659.00
4225	942250	\$669.00	4225	942251	\$669.00	4225	942252	\$679.00
4227	942270	\$669.00	4227	942271	\$669.00	4227	942272	\$679.00
4229	942290	\$669.00	4229	942291	\$669.00	4229	942292	\$679.00
4231	942310	\$689.00	4231	942311	\$689.00	4231	942312	\$699.00
4233	942330	\$689.00	4233	942331	\$689.00	4233	942332	\$699.00
4625	946250	\$709.00	4625	946251	\$709.00	4625	946252	\$719.00
4627	946270	\$709.00	4627	946271	\$709.00	4627	946272	\$719.00
4629	946290	\$709.00	4629	946291	\$709.00	4629	946292	\$719.00
4631	946310	\$729.00	4631	946311	\$729.00	4631	946312	\$739.00
4633	946330	\$729.00	4633	946331	\$729.00	4633	946332	\$739.00

Continued →

Ultraview

Continued

Masonry doors overlap the fireplace opening and require a suitable and smooth and level mounting surface for installation. Please measure the opening dimensions of your fireplace and refer to the sizing chart on the previous page to determine the proper size you will need to order.

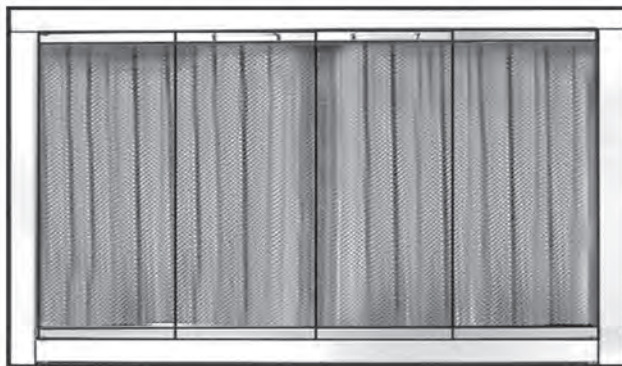

Stock Numbers and Suggested Retail Pricing

Every effort is made to keep "Stock" doors indicated in Bold letters available for immediate shipment. All others will ship within 10 to 15 business days. Stock doors with special options such as glass color change will ship in 10 to 15 business days. For an additional \$30 (net), non-stock items will be shipped within seven business days by placing "Hearth Express" on your faxed order.

Flat Black & Polished Brass

Size	Stock No.	Retail Price
3825	938254	\$639.00
3827	938274	\$639.00
3829	938294	\$639.00
3831	938314	\$659.00
3833	938334	\$659.00
4225	942254	\$679.00
4227	942274	\$679.00
4229	942294	\$679.00
4231	942314	\$699.00
4233	942334	\$699.00
4625	946254	\$719.00
4627	946274	\$719.00
4629	946294	\$719.00
4631	946314	\$739.00
4633	946334	\$739.00

Satin Nickel

Size	Stock No.	Retail Price
3825	938255	\$639.00
3827	938275	\$639.00
3829	938295	\$639.00
3831	938315	\$659.00
3833	938335	\$659.00
4225	942255	\$679.00
4227	942275	\$679.00
4229	942295	\$679.00
4231	942315	\$699.00
4233	942335	\$699.00
4625	946255	\$719.00
4627	946275	\$719.00
4629	946295	\$719.00
4631	946315	\$739.00
4633	946335	\$739.00

Vintage Iron

Size	Stock No.	Retail Price
3825	938256	\$639.00
3827	938276	\$639.00
3829	938296	\$639.00
3831	938316	\$659.00
3833	938336	\$659.00
4225	942256	\$679.00
4227	942276	\$679.00
4229	942296	\$679.00
4231	942316	\$699.00
4233	942336	\$699.00
4625	946256	\$719.00
4627	946276	\$719.00
4629	946296	\$719.00
4631	946316	\$739.00
4633	946336	\$739.00

Antique Bronze

Size	Stock No.	Retail Price
3825	938257	\$639.00
3827	938277	\$639.00
3829	938297	\$639.00
3831	938317	\$659.00
3833	938337	\$659.00
4225	942257	\$679.00
4227	942277	\$679.00
4229	942297	\$679.00
4231	942317	\$699.00
4233	942337	\$699.00
4625	946257	\$719.00
4627	946277	\$719.00
4629	946297	\$719.00
4631	946317	\$739.00
4633	946337	\$739.00

Special Options

Cabinet Door Set	\$30.00 Net
Clear or Gray Glass	\$30.00 Net
Different Trim Finish	\$30.00 Net
Beveled Glass	\$125.00 Net

How to Measure for a Custom Masonry

To order a custom fit door, finished dimensions must be determined prior to ordering. Please use the guide lines below to determine finished dimensions, then use the finished dimensions to determine the price of the door on the next page.

For the best fit, the fireplace opening should meet the following requirements:

- Suitable mounting surface on top and bottom of opening.
- Mounting surfaces must be level.
- Fireplace opening should be square & level. Doors are made square. Any out of square conditions on the opening will be exaggerated or will prevent installation.

Measuring the Fireplace Opening

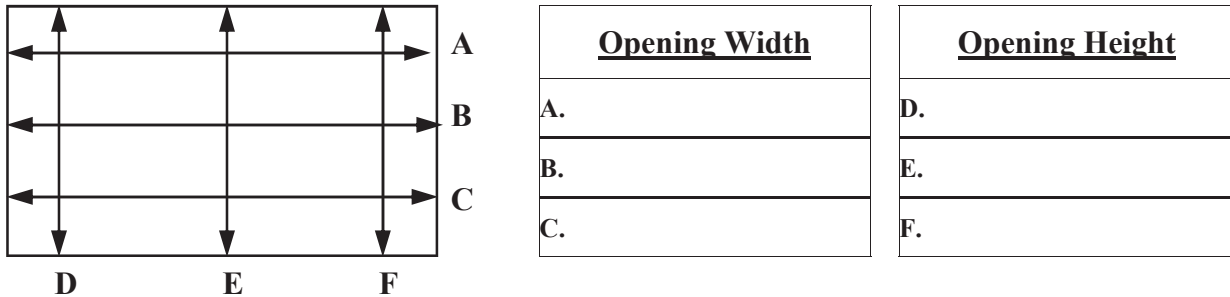

Slimline & Serenity

- **INSIDE FIT:** To determine finished dimensions, we recommend using the smallest opening Dimensions and subtracting 1/8" from the overall width & 1/16" from the height.
- **OVERLAP FIT:** To determine finished dimensions, we recommend using the smallest opening dimensions and adding from 1" minimum to 3" maximum onto the overall width & from 1/2" minimum to 3" maximum onto the height.

Sentry Premiere, Contemporary, Traditional & Classic

- **INSIDE FIT:** To determine finished dimensions, we recommend using the smallest opening Dimensions and subtracting 1/8" from the overall width & 1/16" from the height.
- **OVERLAP FIT:** To determine finished dimensions, we recommend using the smallest opening dimensions and adding from 1" minimum to 6" maximum onto the overall width & from 1/2" minimum to 3" maximum onto the height.

Ultraview, Mystique & Horizon

- **INSIDE FIT:** To determine finished dimensions, we recommend using the smallest opening Dimensions and subtracting 1/8" from the overall width & 1/16" from the height.
- **OVERLAP FIT:** To determine finished dimensions, we recommend using the smallest opening dimensions and adding from 1" minimum to 2" maximum onto the overall width & from 1/2" minimum to 1-1/2" maximum onto the height.

Finished Dimensions

Width

Height

Custom Door Pricing

Prices are based on finished dimensions. To determine finished dimensions, please refer to the previous page. In vast majority of cases, the order is completed within 10 to 15 business days. For a net charge of \$60.00, your order can be filled within 7 business days. If so desired, please indicate "Hearth Express" on your purchase order.

Finished Width	Finished Height	Slimline	Serenity	Sentry Premiere and Contemporary	Sentry Traditional and Classic
Up to 42 15/16"	Up to 33"	\$630.00	\$690.00	\$720.00	\$750.00
Up to 42 15/16"	Up to 34"	\$650.00	\$710.00	\$740.00	\$770.00
Up to 42 15/16"	Up to 35"	\$670.00	\$730.00	\$760.00	\$790.00
Up to 42 15/16"	Up to 36"	\$690.00	\$750.00	\$780.00	\$820.00
43 to 52 15/16"	Up to 33"	\$740.00	\$810.00	\$840.00	\$870.00
43 to 52 15/16"	Up to 34"	\$760.00	\$830.00	\$860.00	\$890.00
43 to 52 15/16"	Up to 35"	\$780.00	\$850.00	\$880.00	\$910.00
43 to 52 15/16"	Up to 36"	\$800.00	\$870.00	\$900.00	\$930.00
53 to 62 15/16"	Up to 33"	N/A	N/A	\$1200.00	\$1240.00
53 to 62 15/16"	Up to 34"	N/A	N/A	\$1230.00	\$1270.00
53 to 62 15/16"	Up to 35"	N/A	N/A	\$1260.00	\$1300.00
53 to 62 15/16"	Up to 36"	N/A	N/A	\$1290.00	\$1330.00
63 To 66"	Up to 33"	N/A	N/A	\$1500.00	\$1550.00
63 To 66"	Up to 34"	N/A	N/A	\$1540.00	\$1590.00
63 To 66"	Up to 35"	N/A	N/A	\$1580.00	\$1630.00
63 To 66"	Up to 36"	N/A	N/A	\$1620.00	\$1670.00

Finished Width	Finished Height	Ultraview	Mystique	Horizon
Up to 42 15/16"	Up to 33"	\$840.00	\$840.00	\$790.00
Up to 42 15/16"	Up to 34"	\$860.00	\$860.00	\$810.00
Up to 42 15/16"	Up to 35"	\$880.00	\$880.00	\$830.00
Up to 42 15/16"	Up to 36"	\$900.00	\$900.00	\$850.00
43 to 52 15/16"	Up to 33"	\$970.00	\$970.00	\$920.00
43 to 52 15/16"	Up to 34"	\$990.00	\$990.00	\$940.00
43 to 52 15/16"	Up to 35"	\$1010.00	\$1010.00	\$960.00
43 to 52 15/16"	Up to 36"	\$1030.00	\$1030.00	\$980.00
53 to 62 15/16"	Up to 33"	\$1230.00	\$1230.00	\$1160.00
53 to 62 15/16"	Up to 34"	\$1260.00	\$1260.00	\$1190.00
53 to 62 15/16"	Up to 35"	\$1290.00	\$1290.00	\$1220.00
53 to 62 15/16"	Up to 36"	\$1320.00	\$1320.00	\$1250.00
63 To 64"	Up to 33"	\$1550.00	\$1550.00	\$1300.00
63 To 64"	Up to 34"	\$1580.00	\$1580.00	\$1330.00
63 To 64"	Up to 35"	\$1610.00	\$1610.00	\$1360.00
63 To 64"	Up to 36"	\$1640.00	\$1640.00	\$1390.00

Beveled Glass \$125.00
(No Discount)

Hearth Express \$60 (Net)
Will Ship Within 7 Business
Days (Not Available for
Bevel Glass)

To Order a Custom Door, a
Custom Order Form Must
be Used.

Hearth Craft Custom Ma-
sonry Doors are not in-
tended for Zero Clear-
ance Fireplaces, Vent
Free Fireplaces or Fire-
places with Vent Free Gas
Logs.

Custom Masonry Order Form

Orders are non-cancelable after 24 hours.

Acct Name: _____

Ship To: _____

Phone : _____

P.O. # _____ Tag: _____

Order Date: _____

Hearth Express? ____ (\$60.00 Net Per door)

Please check one

Inside Fit **Overlap Fit**

By ordering a Custom Door, you have the option of mixing finishes as well as your choice of gray, bronze or clear glass. All Hearth Craft Masonry Series Doors are strictly masonry doors and are not intended for Zero Clearance (prefabricated) fireplaces. These doors are also not intended for fireplaces with vent free gas logs. Allow 10 to 15 business days for order.

<input type="checkbox"/>	Slimline	Frame Finish	Door Trim Finish	Handle Finish	Glass Color	Door Style
<input type="checkbox"/>	Contemporary	<input type="checkbox"/> Polished Brass	<input type="checkbox"/> Polished Brass	<input type="checkbox"/> Polished Brass	<input type="checkbox"/> Clear	<input type="checkbox"/> Full Fold
<input type="checkbox"/>	Premiere	<input type="checkbox"/> Antique Brass	<input type="checkbox"/> Antique Brass	<input type="checkbox"/> Antique Brass	<input type="checkbox"/> Gray	<input type="checkbox"/> Cabinet
<input type="checkbox"/>	Classic	<input type="checkbox"/> Flat Black	<input type="checkbox"/> Flat Black	<input type="checkbox"/> Flat Black	<input type="checkbox"/> Bronze	<input type="checkbox"/> Fixed Panel
<input type="checkbox"/>	♦Traditional	<input type="checkbox"/> Satin Nickel	<input type="checkbox"/> Satin Nickel	<input type="checkbox"/> Satin Nickel	<input type="checkbox"/> Beveled ♦♦	<input type="checkbox"/> No Mesh

♦ Traditional is track only. ♦ Traditional is not available in beveled glass.

<input type="checkbox"/>	Ultraview	<input type="checkbox"/> Polished Brass	<input type="checkbox"/> Polished Brass	<input type="checkbox"/> Polished Brass	<input type="checkbox"/> Clear	<input type="checkbox"/> Full Fold
<input type="checkbox"/>	Serenity	<input type="checkbox"/> Antique Brass	<input type="checkbox"/> Antique Brass	<input type="checkbox"/> Antique Brass	<input type="checkbox"/> Gray	<input type="checkbox"/> Cabinet
		<input type="checkbox"/> Flat Black	<input type="checkbox"/> Flat Black	<input type="checkbox"/> Flat Black	<input type="checkbox"/> Bronze	<input type="checkbox"/> Fixed Panel
		<input type="checkbox"/> Satin Nickel	<input type="checkbox"/> Satin Nickel	<input type="checkbox"/> Satin Nickel	<input type="checkbox"/> Beveled ♦♦	<input type="checkbox"/> No Mesh
		<input type="checkbox"/> Antique Bronze	<input type="checkbox"/> Antique Bronze	<input type="checkbox"/> Antique Bronze		
		<input type="checkbox"/> Vintage Iron	<input type="checkbox"/> Vintage Iron	<input type="checkbox"/> Vintage Iron		

<input type="checkbox"/>	Mystique	<input type="checkbox"/> Polished Brass	<input type="checkbox"/> Polished Brass	<input type="checkbox"/> Polished Brass	<input type="checkbox"/> Clear	<input type="checkbox"/> Full Fold
<input type="checkbox"/>	Horizon	<input type="checkbox"/> Flat Black	<input type="checkbox"/> Antique Brass	<input type="checkbox"/> Antique Brass	<input type="checkbox"/> Gray	<input type="checkbox"/> Cabinet
			<input type="checkbox"/> Flat Black	<input type="checkbox"/> Flat Black	<input type="checkbox"/> Bronze	<input type="checkbox"/> Fixed Panel
			<input type="checkbox"/> Satin Nickel	<input type="checkbox"/> Satin Nickel	<input type="checkbox"/> Beveled ♦♦	<input type="checkbox"/> No Mesh
			<input type="checkbox"/> Chrome	<input type="checkbox"/> Chrome		
			<input type="checkbox"/> Gloss Black	<input type="checkbox"/> Gloss Black		

<input type="checkbox"/>	Opening Dimensions of Fireplace	Width	Height	Qty
<input type="checkbox"/>	Finished Dimensions of Door	_____	_____	_____

Things to Remember...

- Any missing information from this form could result in delay with your order.
- If you do not receive an order acknowledgement within 24 business hours, please call Hearth Craft.
- Please allow up to ten business days from date of order entry for shipping.
- Hearth Express orders will ship within 7 business days of order entry.
- ♦♦Orders with beveled glass could take up to 21 business days to complete.

Rainbow

Zero Clearance Fireplace Glass Door

Features

- 5/8” thick by 1– 1/16" wide anodized aluminum frame to provide finish protection and heat resistance.
- The Zero Clearance design provides air gaps between each glass panel, to ensure proper airflow required by firebox manufacturers.
- Trimless "full-fold" doors with standard bronze tempered and edged glass open a full 180° for enhanced viewing, easy cleaning, and safety.
- Frames are profile 68 (slanted, square frame, subtle in appearance) to fit snug inside the box.
- While many stock sizes are available, doors may also be ordered as custom, inside fit as well as overlap fit.



Available finishes are:

Polished Brass, Antique Brass, Polished Chrome, Gloss Black, Flat Black and Satin Nickel . Mixed finishes may be ordered also (this makes it a custom).

Other custom options are:

Bronze (standard), clear & gray glass, bevel glass, tracked doors (inside fit only), cabinet style door set & fixed panel (for “L” shaped fireboxes).

Finish	Custom Stock #
Polished Brass	680013FS
Antique Brass	680055FS
Flat Black	680026FSF
Gloss Black	680026FS
Satin Nickel	680066FS
Chrome	680011FS
*Mixed Finishes	680000FS
<i>*E.g.- Flat Black Frame w/ Satin Nickel trim & handles</i>	

All standard Rainbow door model numbers are listed in the **cross reference table**. All standard stock doors are Profile 68 (slanted, square frame), inside fit, full-fold, and come standard with bronze glass. Box manufacturers sometimes make slight modifications without changing model numbers. Therefore, it is wise to double check the opening dimensions of the box against our cross reference table. Box Models not listed or opening dimensions not corresponding with model numbers in the table may be custom-made based on the opening measurements provided by the customer. Custom door pricing is based on the opening width and height of the fireplace opening. Choice of finish, mixing frame and trim colors, and glass tint (clear, bronze/tinted, grey/smoked) does not affect the price. Custom stock numbers (left) are based on finish only.

Rainbow Cross Reference Table

FMI

Box Model No.	Box Opening	Stock #	Sugg. Retail
GL650, GL850	31 7/8 X 21 7/8"	FMI-3101 CUSTOM	\$419.00
C36	35 X 21"	CUSTOM ORDER FORM	\$419.00
3600, 3601, BAJA3600/ 3601	36 X 21 7/16"	MAJ-3601/AB-PB-BLK-SN	\$399.00
B36	36 X 21 3/8"	CUSTOM ORDER FORM	\$419.00
(36E, 36EII New Models), FL3000E/EP, GL3100E/EP	36 X 22 1/8"	FMI-3601 CUSTOM	\$419.00
GL3000/P, GL3100/P	36 X 22 1/4"	FMI-3604 CUSTOM	\$419.00
(36E, 36EC Old Models), 36ECD	36 X 23 1/4"	FMI-3603 CUSTOM	\$419.00
GL36ST, GL36ST-E, GL36ST-P, GL36ST-EP	36 1/2 X 20 1/2"	FMI-3606 CUSTOM	\$419.00
38TS, 38TSF	38 x 20"	FMI-3801 CUSTOM	\$419.00
42E, 42EC, GL4000, GL4000E/EP, GL4100, GL4100E/EP	42 X 22"	FMI-4202 CUSTOM	\$439.00
B42	42 X 21 3/8"	CUSTOM ORDER FORM	\$439.00
42GCH	42 X 22 3/4"	CUSTOM ORDER FORM	\$439.00
42C, 42MC, C42	42 X 24"	MAJ-4204/AB-PB-BLK	\$419.00
I100E	43 1/2 X 29"	CUSTOM ORDER FORM	\$439.00

Heat-N-Glo

Box Model No.	Box Opening	Stock #	Sugg. Retail
HST-38, HST-38MH	31 1/2 X 20"	HNG-3801 CUSTOM	\$419.00
EM42	36 X 19 1/8"	HNG-3601 CUSTOM	\$419.00
RHW-41, RSW41, HST42D	36 X 20 1/2"	HET-3602/AB-PB-BLK-SN	\$399.00
HST-42, HST-42CF	36 X 20 3/4"	HNG-3604 CUSTOM	\$419.00
HST-42D	36 X 20 7/8"	CUSTOM ORDER FORM	\$419.00
RH41, RS41	36 X 21 7/16"	MAJ-3601/AB-PB-BLK-SN	\$399.00
EM41	36 X 21 1/2"	HNG-3602 CUSTOM	\$419.00
EM415, EM415R	36 X 23 1/2"	CUSTOM ORDER FORM	\$419.00
EXCLAIM-36	36 X 28 1/2"	CUSTOM ORDER FORM	\$419.00
RHW-47, RSW-47	42 X 20 1/2"	HET-4204/AB-PB-BLK	\$419.00
HST-48D	42 X 23"	CUSTOM ORDER FORM	\$439.00
EM485T	42 X 23 3/8"	CUSTOM ORDER FORM	\$439.00
HST-48, EM-48, RHW51	42 X 24"	MAJ-4204/AB-PB-BLK	\$419.00
EXCLAIM-42	42 X 28 1/2"	CUSTOM ORDER FORM	\$439.00
RHW-56	48 X 28"	HET-4801 CUSTOM	\$459.00
EXCLAIM-50	50 X 33"	CUSTOM ORDER FORM	\$469.00

Heatilator

Box Model No.	Box Opening	Stock #	Sugg. Retail
SC60	36 X 19 1/8"	CUSTOM ORDER FORM	\$419.00
MH36, E36 ,E36I ,EC36, EC36I, EL36 (Add 1/2" to Height on Glass & Track)	36 X 20 1/2"	HET-3602/AB-PB-BLK-SN	\$399.00
ST36D, HC36, HR36	36 X 20 7/8"	HET-3606 CUSTOM	\$419.00
HB36A, HB36AI, DX36AI, TD36B	36 X 20 15/16"	HET-3601 CUSTOM	\$419.00
T588, T3600,	36 X 21"	HET-3605 CUSTOM	\$419.00
HD36B, HD36BI, ST36B, ST36C	36 X 22 1/2"	HET-3604 CUSTOM	\$419.00
(A36C, A36R New Models)	36 X 23 3/8"	CUSTOM ORDER FORM	\$419.00
(A36C, A36R Old Models), EM415	36 X 23 1/2"	HET-3600 CUSTOM	\$419.00
E39, E39I, EC39, EC39I (Add 1/2" to Height on Glass & Track)	39 X 20 1/2"	HET-3901 CUSTOM	\$419.00
E42, EC42, E42I, EC42I, EL42 (Add 1/2" to Height on Glass & Track)	42 X 20 1/2"	HET-4204/AB-PB-BLK-SN	\$419.00
HB42A, HB42AI	42 X 20 15/16"	HET-4202 CUSTOM	\$439.00
HD42B, HD42BI	42 X 22 1/2"	HET-4201 CUSTOM	\$439.00
DX42AI, TD42B	42 X 22 15/16"	HET-4203 CUSTOM	\$439.00
ST42A	42 X 23"	HET-4205 CUSTOM	\$439.00
(A42C, A42R New Models)	42 x 23 3/8"	CUSTOM ORDER FORM	\$439.00
(A42C, A42R Old Models)	42 X 23 1/2"	HET-4200/AB-PB-BLK-SN	\$419.00
T768, T4200	42 X 24"	MAJ-4204/AB-PB-BLK	\$419.00
TD46DBI	46 X 26 15/16"	HET-4207 CUSTOM	\$449.00
T4800	48 X 28"	CUSTOM ORDER FORM	\$459.00

Continued on next page ►

Rainbow Cross Reference Table

(Continued)

Majestic

Box Model No.	Box Opening	Stock #	Sugg. Retail
LST36	31 1/2 X 20"	MAJ-3604 CUSTOM	\$419.00
STR33	33 X 21"	CUSTOM ORDER FORM	\$419.00
MBC36, MBC36A	36 X 20"	CUSTOM ORDER FORM	\$419.00
BR36, BC36, SR36, SC36, STR36, BFC36	36 X 21"	MAJ-3600/AB-PB-BLK-SN	\$399.00
WMC36	36 X 21"	CUSTOM ORDER FORM	\$419.00
MSF36, MST36	36 X 21 3/8"	MAJ-3602 CUSTOM	\$419.00
MBU36, MBU36I, MBUC36, MBUC36I, R36, RC36, 36ST, CR36R	36 X 21 7/16"	MAJ-3601/AB-PB-BLK-SN	\$399.00
(BT836, BT836I Slanted Frame Only), G450	36 X 21 1/2"	MAJ-3603 CUSTOM	\$419.00
SHR36 (Overlap fit only. Special Mounting Brackets Included)	36 X 24"	OVERLAP ONLY FORM	\$419.00
SH36, M36, MD36, L36S, L36, L36A, L36B, SR36A, SC36A	36 X 24"	MAJ-3605 CUSTOM	\$419.00
(BR42, SR42, SC42 Old Models), STR42	42 X 21"	MAJ-4200/AB-PB-BLK-SN	\$419.00
WMC42	42 X 21"	CUSTOM ORDER FORM	\$439.00
MBU42, MBU42I, MBUC42, MBUC42I, MR42, MRC42, 42ST, MBC42, MBCU42/F	42 X 21 7/16"	MAJ-4201/PB-BLK	\$419.00
BT842, BT842I, G490	42 X 21 1/2"	MAJ-4202 CUSTOM	\$439.00
SHR42 (Overlap Fit Only. Special Mounting Brackets Included)	42 X 24"	OVERLAP ONLY FORM	\$439.00
SR42, SR42A (New Models), SC42A, SH42, MSF42 New Models	42 X 24"	MAJ-4204/AB-PB-BLK	\$419.00
SHR42A (Overlap Fit Only. Special Mounting Brackets Included)	42 X 28 1/2"	OVERLAP ONLY FORM	\$439.00
SH48	48 X 28 1/2"	MAJ-4801 CUSTOM	\$459.00
SHR48 (Overlap Fit Only. Special Mounting Brackets Included)	48 X 28 1/2"	OVERLAP ONLY FORM	\$459.00
SHR52 (Overlap Fit Only. Special Mounting Brackets Included)	52 X 33"	OVERLAP ONLY FORM	\$469.00

Marco

Box Model No.	Box Opening	Stock #	Sugg. Retail
B36CF, B36HC, B36HCI, A36STD, D36	36 X 20 3/16"	MCO-3601/AB-PB-BLK-SN	\$399.00
C36CF, C36HC, C36HCI	36 X 21 5/8"	MCO-3602 CUSTOM	\$419.00
B41CF, B41HC, B41HCI, D41	41 X 22 5/16"	MCO-4101/AB-PB-BLK-SN	\$419.00
41M	41 1/4 X 25"	MCO-4102 CUSTOM	\$439.00
Architect A46	46 x 28 1/4"	MCO-4601 CUSTOM	\$459.00

Martin

Box Model No.	Box Opening	Stock #	Sugg. Retail
SA36, SC36, SF36	36 X 19 3/8"	MAT-3601 CUSTOM	\$419.00
LF36E	36 X 20 3/4"	MAT-3602 CUSTOM	\$419.00
LF36U	36 X 21 3/32"	MAT-3603 CUSTOM	\$419.00
400BWBIA, 400BWBCA, 400 BWBCIA	36 X 21 1/2"	CUSTOM ORDER FORM	\$419.00
SSTB	38 X 23 1/4"	CUSTOM ORDER FORM	\$419.00
SB4800 (Overlap Fit Only. Special Mounting Brackets Included)	38 X 27"	OVERLAP ONLY FORM	\$419.00
SA39	39 X 19 3/8"	MAT-3901 CUSTOM	\$419.00
500BWBIA, 500BWBCA, 500 BWBCIA	42 X 21 1/2"	CUSTOM ORDER FORM	\$439.00
SA42, SC42, BE42	42 X 21 13/16"	MAT-4201 CUSTOM	\$439.00
LF42E	42 X 23 1/4"	MAT-4202 CUSTOM	\$439.00
LF42U	42 X 23 3/8"	MAT-4203 CUSTOM	\$439.00
SB5400 (Overlap Fit Only. Special Mounting Brackets Included)	44 X 27"	OVERLAP ONLY FORM	\$439.00
SB6000 (Overlap Fit Only. Special Mounting Brackets Included)	50 X 30"	OVERLAP ONLY FORM	\$469.00

Preway

Box Model No.	Box Opening	Stock #	Sugg. Retail
B128DEM	28 X 16"	PRE-2801 CUSTOM	\$419.00
PB36D, B136-SEM, B136DEM	36 X 18"	PRE-3601 CUSTOM	\$419.00
BE41, FF41	36 X 21 1/2"	PRE-3602 CUSTOM	\$419.00
B142D	42 X 20"	PRE-4202 CUSTOM	\$439.00
FF48	42 X 23"	PRE-4201 CUSTOM	\$439.00

Continued on next page ►

Rainbow Cross Reference Table

(Continued)

Superior / Lennox

Box Model No.	Box Opening	Stock #	Sugg. Retail
G-436D	28 1/4 X 18 1/2"	SUP-2801 CUSTOM	\$419.00
HC3320, HC-3550, GRD-5500, GRD5500-2, GHC-5500, GHC5500-2, RD3300	33 1/4 X 21"	SUP-3301 CUSTOM	\$419.00
RD/HC-36, BRF/BCF36, BR-36, BC-36, BBV-36	36 X 20 3/16"	MCO-3601/AB-PB-BLK-SN	\$399.00
COL-3629	36 X 29"	CUSTOM ORDER FORM	\$419.00
KC38, KC38-3, KR38, KR38-3, RD3800, BRF3875, HC3820, BCF3885, HCE4050	38 X 21"	SUP-3801/PB-BLK-SN	\$399.00
LBR-38, LBC-38, LBR-3824, LBC-3824	38 X 24 5/8"	SUP-3802 CUSTOM	\$419.00
FP-38	38 X 25 1/2"	CUSTOM ORDER FORM	\$419.00
(ST-3840A Old Models)	39 X 22 1/4"	CUSTOM ORDER FORM	\$419.00
(ST-3840A New Models)	39 1/2" X 23 1/2"	SUP-3803 CUSTOM	\$419.00
RD/HC42, BR42, BC42, BBV42, BC42-2	41 X 22 5/16"	MCO-4101/AB-PB-BLK-SN	\$419.00
LA-41	41 1/4 X 25"	CUSTOM ORDER FORM	\$439.00
BRF-4375, RD-4300, BCF-4385, HCE-4320, HCE-4550, KR4300, KC43, KR43	42 3/4 X 21"	SUP-4201 CUSTOM	\$439.00
LBR-43, LBC-43, LBR-4324, LBC-4324, LS-43ST	42 3/4 X 24 5/8"	SUP-4202 CUSTOM	\$439.00
FP-43	42 3/4 X 25 1/2"	CUSTOM ORDER FORM	\$439.00
LBV-43	43 1/2 X 24 5/8"	CUSTOM ORDER FORM	\$439.00
TM-4500, TMC-4500	45 1/4 X 29"	SUP-4501 CUSTOM	\$459.00
EST-48, EST-4800 (Overlap Fit Only. Special Mounting Brackets Included)	48 X 28"	OVERLAP ONLY FORM	\$459.00

Temco

Box Model No.	Box Opening	Stock #	Sugg. Retail
GC36	33 1/2 X 21 13/16"	TEM-3301 CUSTOM	\$419.00
TF36, TF36I, TL36, TL36I	36 X 21"	CUSTOM ORDER FORM	\$419.00
TLC36-3	36 X 21 5/8"	CUSTOM ORDER FORM	\$419.00
TFC36-3	36 X 21 7/8"	TEM-3601 CUSTOM	\$419.00
TLC36-2, GLC36, TFC36	36 X 22"	TEM-3602 CUSTOM	\$419.00
TBF36, TBST36	36 X 24"	MAJ-3605 CUSTOM	\$419.00
TSH36 (Overlap Fit Only. Special Mounting Brackets Included)	36 X 24"	OVERLAP ONLY FORM	\$419.00
TFC39-3, TFC39-2	39 X 21 7/8"	TEM-3901 CUSTOM	\$419.00
TCH4125	41 X 25"	TEM-4101 CUSTOM	\$439.00
TF42, TF42I, TL42, TL42I	42 X 19"	CUSTOM ORDER FORM	\$439.00
(TFC42-4, TLC42-4 Old Models)	42 X 21 5/8"	CUSTOM ORDER FORM	\$439.00
(TFC42-4, TLC42-4 New Models)	42 X 21 7/8"	CUSTOM ORDER FORM	\$439.00
GLC-42	42 X 22"	TEM-4202 CUSTOM	\$439.00
TBF42, TBST42	42 X 24"	MAJ-4204/AB-PB-BLK-SN	\$419.00
TSH42 (Overlap Fit Only. Special Mounting Brackets Included)	42 X 28 1/2"	OVERLAP ONLY FORM	\$439.00
TCH4429	44 X 29"	TEM-4401 CUSTOM	\$439.00
TBF47	47 X 28"	TEM-4701 CUSTOM	\$459.00
TSH52 (Overlap Fit Only. Special Mounting Brackets Included)	52 X 33"	OVERLAP ONLY FORM	\$469.00

Hearth Craft Rainbow Doors are not intended for use on vent free fireplaces. Hearth Craft is not liable for improper door sizes due to changes in box opening dimensions. Box opening dimensions that correspond with other manufacturer's model numbers may not be compatible. Custom Rainbow orders are non-cancelable after 24 hours.

AB = ANTIQUE BRASS
 PB = POLISHED BRASS
 BLK = FLAT BLACK
 SN = SATIN NICKEL

Custom Rainbow Order Form

Profile 68 (Inside or Overlap Fit)

Acct Name: _____

Ship To: _____

Phone : _____

P.O. # _____ Tag: _____

Order Date: _____

Please check one

Hearth Express? _____ (Add \$30 Net per door) **Inside Fit** **Overlap Fit**

Doors ordered as "Hearth Express" will ship within 7 business days

The Profile 68 Rainbow has a slanted, square frame. By ordering a Custom Rainbow, you have the option of mixing finishes as well as your choice of gray, bronze or clear glass. Rainbow Series are strictly Zero Clearance doors and are not intended for masonry fireplaces. These doors are also not intended for vent free gas logs or fireplaces. All Custom Doors will ship in up to ten business days. Doors with bevel glass will ship within twenty one business days. Order is non-cancelable after 24 hours.

Profile 68 Frame Finish	Door Trim Finish	Handle Finish	Glass Color	Door Style
<input type="checkbox"/> Polished Brass	<input type="checkbox"/> Polished Brass	<input type="checkbox"/> Polished Brass	<input type="checkbox"/> Clear	<input type="checkbox"/> Full Fold
<input type="checkbox"/> Antique Brass	<input type="checkbox"/> Antique Brass	<input type="checkbox"/> Antique Brass	<input type="checkbox"/> Gray	<input type="checkbox"/> Cabinet
<input type="checkbox"/> Flat Black	<input type="checkbox"/> Flat Black	<input type="checkbox"/> Flat Black	<input type="checkbox"/> Bronze	<input type="checkbox"/> Track
<input type="checkbox"/> Gloss Black	<input type="checkbox"/> Gloss Black	<input type="checkbox"/> Gloss Black		<small>(Pol. Brass, Gloss Black & Chrome Only)</small>
<input type="checkbox"/> Satin Nickel	<input type="checkbox"/> Satin Nickel	<input type="checkbox"/> Chrome	<input type="checkbox"/> Beveled	<input type="checkbox"/> Fixed Panel
<input type="checkbox"/> Chrome	<input type="checkbox"/> Chrome	<small>(Choose Chrome for Satin Nickel Finish)</small>		

•Important• **Required Information**

Manufacturer Model # _____ or Rainbow Model # _____

Please Check One Opening Dimensions of Box Finished Dimensions of Door

<u>Width</u>	<u>Height</u>
<u>Qty</u>	

Opening Width	Sugg. Retail Price
Up to 40"	\$419.00
40 1/16 to 45"	\$439.00
45 1/16 to 48"	\$459.00
48 1/16 to 52"	\$469.00
Beveled Glass	\$125.00 (Net)

◆ Doors to fit an "L" shaped fireplace will require two separate custom order forms.

Rainbow Glass & Track Order Form

Acct Name: _____

Ship To: _____

Phone : _____

P.O. # _____ Tag: _____

Order Date: _____

Hearth Express? _____ Yes

(Additional \$30.00 Net per door.

Will ship within 7 business days.)

Ordered By: _____

By ordering a Rainbow Glass & Track, you have the option of mixing finishes as well as your choice of gray, bronze or clear glass. Rainbow Series are strictly Zero Clearance doors and are not intended for masonry fireplaces. These doors are also not intended for vent free gas logs or fireplaces. All Custom Doors will ship in up to ten business days. Doors with bevel glass will ship within twenty one business days. Order is non-cancelable after 24 hours.

Frame Finish	Door Trim Finish	Handle Finish	Glass Color
<input type="checkbox"/> Polished Brass	<input type="checkbox"/> Polished Brass	<input type="checkbox"/> Polished Brass	<input type="checkbox"/> Clear
<input type="checkbox"/> Gloss Black	<input type="checkbox"/> Antique Brass	<input type="checkbox"/> Antique Brass	<input type="checkbox"/> Gray
<input type="checkbox"/> Chrome	<input type="checkbox"/> Chrome	<input type="checkbox"/> Chrome	<input type="checkbox"/> Bronze
	<input type="checkbox"/> Gloss Black	<input type="checkbox"/> Gloss Black	<input type="checkbox"/> Beveled
	<input type="checkbox"/> Satin Nickel	(Choose Chrome for Satin Nickel Finish as well)	

•Important• Required Information

Manufacturer Model # _____ or Rainbow Model # _____

Opening Dimensions
(Must be Provided)

Width	Height	Qty
Opening Width	Sugg. Retail Price	
Up to 40"	\$339.00	
40 1/16 to 45"	\$349.00	
45 1/16 to 48"	\$359.00	
48 1/16 tp 52"	\$369.00	
Beveled Glass	\$125.00 (Net)	

GLOSSARY OF TERMS

ANODIZED ALUMINUM - Aluminum is a lightweight, yet strong material that can be extruded into many attractive and functional profiles. After the metal is extruded, it is anodized (an electrochemical process that gives the extrusion its color and durability). The coating on the surface of the aluminum is very durable and will not tarnish, even in salt-air climates.

PLATED BRASS - Brass is an alloy of copper and zinc and the color is determined by the amount of copper used.

DAMPER - The mechanism that allows combustion air into the firebox.

EXTRUSION - Aluminum profile shaped with a die under pressure and heat.

HEAT RESISTANT CLEAR FINISH - To prevent tarnish, all of our solid brass and plated brass finishes have been coated with a clear enamel which is baked on at high temperatures, forming a glass-like surface.

LINTEL - Metal bar located at the top of a masonry fireplace which is used to support brick work above the firebox.

MESH CURTAIN - At Hearth Craft, we use 19 gauge tempered steel woven wire which has been darkened to provide a black finish. Black mesh curtain is easier to see through, which permits better visibility of a burning fire. Hearth Craft mesh provides excellent spark protection and allows some regulation of heat by opening and closing.

RISER BAR - A piece of brass 1 5/8" deep and 2" high which is attached to the bottom of glass door enclosures to compensate for raised hearths. These are available for Hearth Craft Sentry and Classic Doors.

TEMPERED GLASS - Tempering is a process in which glass is heated and then rapidly cooled which allows it to resist thermal stress and significant impact. At Hearth Craft we use only the highest quality glass. Each piece of glass is fully tempered to meet the standards of the American National Standards Institute and can generally withstand a minimum temperature of up to 500 degrees Fahrenheit for sustained periods of time. At Hearth Craft we use 3/16" glass rather than the industry standard 1/4" glass. The reason, because 3/16" glass dissipates heat faster and reduces the chance of hot and cold spots. Glass dimensions are calculated to the nearest 1/16th of an inch. The typical gap between the glass panels on a Hearth Craft enclosure is between 1/32nd and 1/16th of an inch. This "spacing" is necessary to allow for expansion of the glass when heated. Hearth Craft is so confident in our product that we warrant all our Masonry glass door enclosures for 5 years.

ZERO CLEARANCE - A factory built fireplace.

LET'S TALK THE SAME LANGUAGE

We want to help our customers recognize the actual parts with ease and convenience when ordering replacement parts.

METAL CLAMP BEHIND CAPS ACT AS A BI-FOLD HINGE

