



NEW G52 Radiant Fyre Gas Log System (see page 10)

TO USE THIS PRICE SHEET

-1- Select Burner System. -2- Select Log Style Design. -3- Select Log Size. -4- Select Controls and Accessories.

BURNER STYLE CODES		GAS LOG AND GLASS CODES															
-LISTED (e.g. RADCO)		DESIGNER SERIES		CHARRED SERIES		GLASS/GEMS SERIES											
G4:	Glowing Ember	RDP:	Golden Oak Designer Plus	CHD:	Char'd Oak	GL-F:	Azuria	GLG-B:	Black Granite								
GX4:	Hvy Duty Glowing Ember	HRD:	Rustic Oak Designer	HCHR:	Burnt Rustic Oak	GL-FR:	Azuria Rfl	GLG-J:	Black Pearl								
VG4-C:	Coal Grate assembly	FO:	Forest Oak	CHS:	Char'd Split	GL-B:	Black	GLG-T:	Blue Topaz								
G45:	Triple T Burner	AO:	American Oak	HCHS:	Burnt Split Oak	GL-BR:	Black Rfl	GLG-D:	Champagne								
G45-SS:	Triple T Stainless Steel	CR:	Cedar	CHRRSO:	Char'd Rugged Split Oak	GL-Z:	Bronze	GLG-R:	Coral Reef								
GX45:	Hvy Duty Triple T Burner	RED:	Red Oak	CHAO:	Char'd American Oak	GL-ZR:	Bronze Rfl	GLG-A:	Deep Amber								
G45-GL:	Triple T Glass Burner	S:	Split Oak	CHCR:	Char'd Cedar	GL-N:	Caribbean Blue	GLG-E:	Emerald								
G45-GL-SS:	Triple T Stainless Glass	SDP:	Split Oak Designer Plus	CHRED:	Char'd Red Oak	GL-NR:	Caribbean Blue Rfl	GLG-C:	Glacier								
G52:	Radiant Fyre Burner	RRSO:	Rugged Split Oak	CHB:	Char'd Royal English Oak	GL-C:	Clear	GLG-K:	Koi								
P:	Flame Pan	WS:	Woodstack	CHH:	Burnt Heritage Oak	GL-QR:	Copper Rfl	GLG-M:	Mint								
PB:	Pan Burner (For Glass)	WO:	Woodland Oak	PN:	Pioneer Oak	GL-E:	Emerald	GLG-P:	Platinum								
EC:	Epic Massive Burner	BD:	Royal English Oak Designer	CHMJ:	Char'd Majestic Oak	GL-ER:	Emerald Rfl	GLG-S:	Sapphire								
-ANSI CERTIFIED		W:	White Birch	CHGO:	Char'd Grizzly Oak	GL-HR:	Gold Rfl										
G45(A):	Triple T Burner	MBW:	Mountain Birch	CHF:	Char'd Forest Oak	GL-S:	Sapphire										
G45(A)-SS:	Triple T Stainless Steel	WCF:	Western Campfire	CHN:	Char'd Northern Oak	GL-W:	Star Fyre										
G45-GL(A)	Triple T Glass	V:	Old English Coal	CHDS:	Charred Oak Stack												
G45-GL-SS	Triple T Stainless Glass	S6:	Split Oak (low set)														
G46:	Glowing Ember	MP:	Mammoth Pine														
PB(A):	Pan (For Glass)	<div style="border: 1px solid black; padding: 5px; display: inline-block;"> For all model numbers: ** = Insert size </div>															
G22-GL:	Contemporary Glass																
										R:	Golden Oak	CLASSIC SERIES		DIAMOND NUGGET SERIES			
										RRO:	Rugged Oak	GLD-C:	Clear	GLD-PB:	Pacific Blue		
										PO:	Post Oak	GLD-SB:	Steel Blue	GLD-L:	Lavender		
		B:	Royal English Oak	GLD-R:	Rosé	GLD-E:	Emerald										
		HR:	Rustic Oak														
		CDR:	Coastal Driftwood														
		GEO SHAPES & RIVER ROCK See Page 18															

SECTION	PAGE	SECTION	PAGE
I Complete Gas Log Sets - G4 & G45 Series Listed	2-3	IX Glass Burner Systems Only - G45, PB & G22 Listed & Certified (Standard & See-Thru and Stainless Steel)	12
II Complete Gas Log Sets - G45 Series ANSI Certified	4-5	X Glass/Gem/Nugget Packages	13
III Complete Gas Log Sets - G46 Series	6-7	XI Vented Burner Systems Only - G4,G45,G46,P (And G45 Stainless Steel)	14-15
IV Complete See-Thru Gas Log Sets - G4 & G45 Series Listed	8	XII Vented Gas Logs Only - G4, G45, G46 & "P" Series	16-17
V Complete See-Thru Gas Log Sets - G45 ANSI Certified	9	XIII Geo Shapes & Stones for Glass Systems	18
VI Complete Gas Log Sets - Charred Evergreen w/ G52 Burner	10	XIV Accessories	18-20
VII Complete Gas Log Sets - Mammoth Pine with Epic Burner	10		
VIII Safety Control Systems	11		

SUPERSEDES ALL OTHER PRICE LISTS • PRICES SUBJECT TO CHANGE WITHOUT NOTICE • ALL PRICES FOB FACTORY. TERMS: NET 30 DAYS

A. G4 & G45 CHARRED SERIES LOG SETS SIZES 16"- 42"

(See section B. below for 12"-19" and 48"-60" sets)

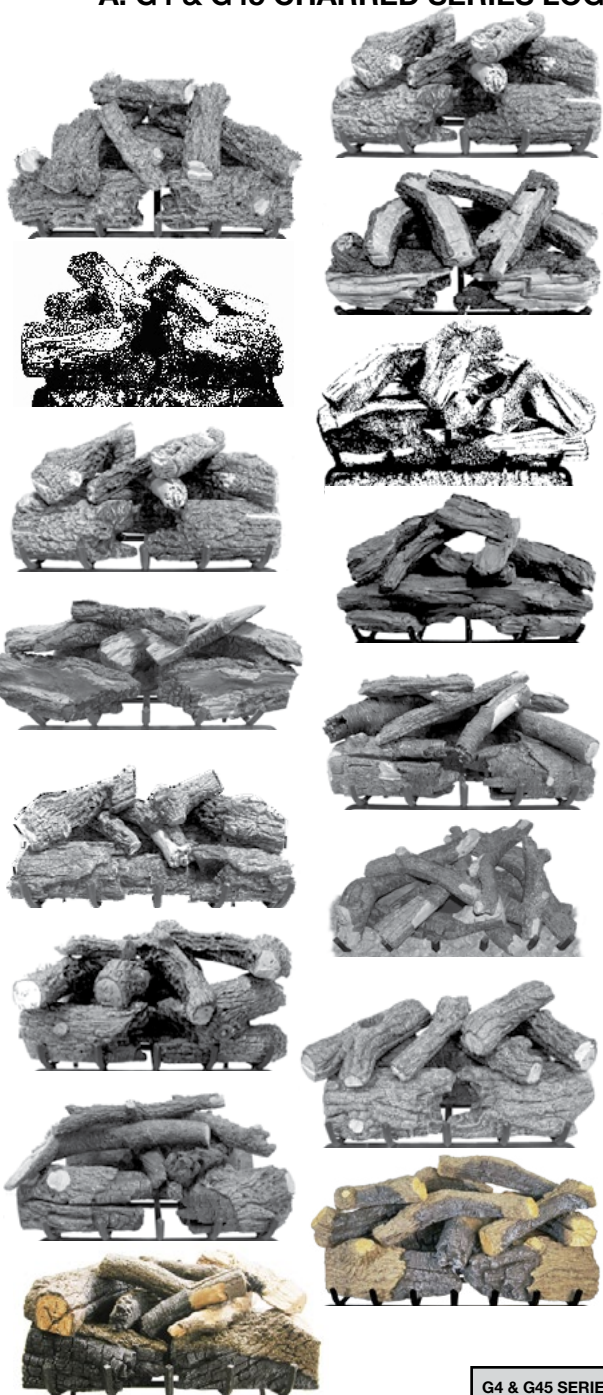

*with Heavy Duty Grate

Style	No.	16"	18"	19"	24"	30"	36" *	42" *
CHARRED OAK	CHDG4-**	440.00	478.00	446.00	535.00	668.00		
	CHDG45-**	475.00	512.00	481.00	581.00	719.00		
BURNT RUSTIC OAK	HCHRG4-**	440.00	478.00	446.00	535.00	668.00		
	HCHRG45-**	475.00	512.00	481.00	581.00	719.00		
CHARRED SPLIT	CHSG4-**		502.00		557.00	693.00	927.00	
	CHSG45-**		536.00		603.00	744.00	983.00	
BURNT SPLIT OAK	HCHSG4-**		502.00		557.00	693.00		
	HCHSG45-**		536.00		603.00	744.00		
CHARRED RUGGED SPLIT OAK	CHRRSOG4-**		522.00		574.00	702.00		
	CHRRSOG45-**		556.00		620.00	753.00		
CHARRED AMERICAN OAK	CHAOG4-**		552.00		610.00	748.00		
	CHAOG45-**		586.00		656.00	799.00		
CHARRED CEDAR	CHCRG4-**		549.00		607.00	737.00		
	CHCRG45-**		583.00		653.00	788.00		
CHARRED RED OAK	CHREDG4-**		549.00		607.00	737.00		
	CHREDG45-**		583.00		653.00	788.00		
CHARRED FOREST OAK	CHFG4-**		526.00		586.00	719.00		
	CHFG45-**		560.00		632.00	770.00		
CHARRED NORTHERN	CHNG4-**		490.00		550.00	681.00		
	CHNG45-**		524.00		596.00	732.00		
CHARRED OAK STACK	CHDSG4-**		476.00		533.00	638.00		
	CHDSG45-**		510.00		579.00	689.00		
CHARRED ROYAL ENGLISH OAK *	CHBGX4-**		570.00		648.00	785.00	1001.00	1347.00
	CHBGX45-**		605.00		694.00	835.00	1057.00	1410.00
BURNT HERITAGE OAK *	CHHGX4-**		555.00		617.00	751.00		
	CHHGX45-**		590.00		763.00	801.00		
PIONEER OAK *	PNGX4-**				636.00	781.00	983.00	
	PNGX45-**				682.00	831.00	1039.00	
NEW! CHARRED GRIZZLY OAK *	CHGOGX4-**				638.00	821.00	1026.00	
	CHGOGX45-**				684.00	871.00	1082.00	
CHARRED MAJESTIC OAK *	CHMJGX4-**				711.00	867.00	1067.00	1339.00
	CHMJGX45-**				757.00	917.00	1123.00	1402.00

G4 & G45 SERIES GLOWING EMBER GAS LOG SETS are Listed up to 30" and include:
 • Gas Logs • Glowing Ember Burner • Custom Grate • Glowing Embers • Sand or Vermiculite • Burner Clips • Damper Clamp • Connector Kit
 See Sections XI, XII, XIII, XIV for component parts and accessories. For See Thru Set see Section VIII
 Shipped for use with Natural Gas - Specify if for Propane Gas by adding a "P" to the product number (RG4-24P), and add \$142.00 for required SPK-26.

B. G4 & G45 SPECIAL SIZED DESIGNER & CLASSIC LOG SETS - SIZES 12"-19" and 48"-72"

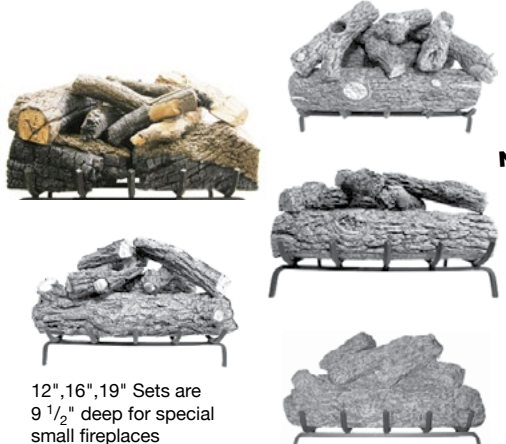

NEW!

Style	No.	12"	16"	19"	48"*	60"*	72"
GOLDEN OAK DESIGNER PLUS	RDPG4-**	353.00	381.00	398.00	1306.00	1523.00	
	RDPG45-**		416.00	433.00	1379.00	1594.00	
CHARRED MAJESTIC OAK	CHMJG4-**				1577.00	1834.00	1985.00
	CHMJG45-**				1650.00	1905.00	2056.00
GOLDEN OAK	RG4-**	294.00	318.00	324.00			
	RG45-**		353.00	359.00			
RUSTIC OAK DESIGNER	HRDG4-**		381.00				
	HRDG45-**		416.00				
RUSTIC OAK	HRG4-**		318.00				
	HRG45-**		353.00				

2 12", 16", 19" Sets are 9 1/2" deep for special small fireplaces

C. G4 & G45 DESIGNER SERIES LOG SETS SIZES 18"-42"

* = Heavy Duty Grate

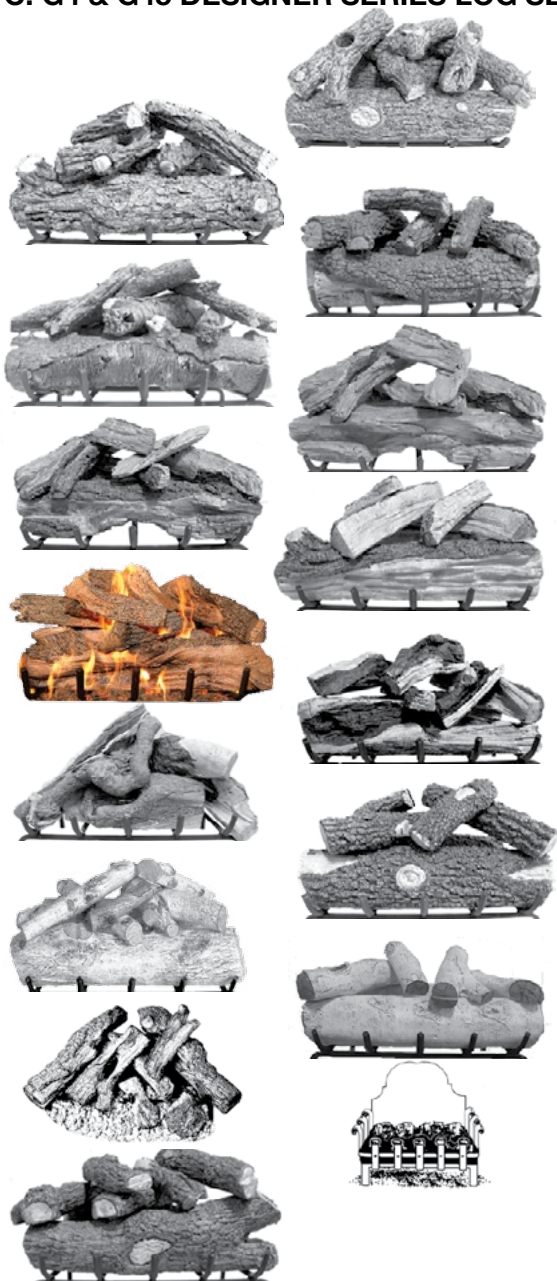

Style	No.	18"	20"	24"	30"	36" *	42" *
GOLDEN OAK DESIGNER PLUS	RDPG4-**	426.00	441.00	485.00	607.00	847.00	1127.00
	RDPG45-**	460.00	475.00	531.00	658.00	903.00	1190.00
RUSTIC OAK DESIGNER	HRDG4-**	418.00		475.00	586.00	847.00	1127.00
	HRDG45-**	452.00		521.00	637.00	903.00	1190.00
FOREST OAK	FOG4-**	458.00		501.00	592.00		
	FOG45-**	492.00		547.00	643.00		
AMERICAN OAK	AOG4-**	509.00		567.00	682.00		
	AOG45-**	543.00		613.00	733.00		
CEDAR	CRG4-**	506.00		570.00	684.00		
	CRG45-**	540.00		616.00	735.00		
RED OAK	REDG4-**	506.00		570.00	684.00		
	REDG45-**	540.00		616.00	735.00		
SPLIT OAK	SG4-**	442.00	457.00	491.00	606.00		
	SG45-**	476.00	491.00	536.00	657.00		
SPLIT OAK DESIGNER PLUS	SDPG4-**	475.00	497.00	531.00	649.00	881.00	
	SDPG45-**	509.00	531.00	577.00	700.00	937.00	
RUGGED SPLIT OAK	RRSOG4-**	497.00		547.00	644.00		
	RRSOG45-**	531.00		593.00	695.00		
WOODSTACK	WSG4-**	532.00		586.00	709.00		
	WSG45-**	566.00		632.00	760.00		
WOODLAND OAK	WOG4-**	419.00	426.00	464.00	564.00		
	WOG45-**	453.00	460.00	510.00	615.00		
MOUNTAIN BIRCH	MBWG4-**	494.00		542.00	630.00		
	MBWG45-**	528.00		588.00	681.00		
WHITE BIRCH	WG4-**	451.00		489.00	574.00		
	WG45-**	485.00		535.00	625.00		
WESTERN CAMPFYRE	WCFG4-**	517.00		579.00	702.00		
	WCFG45-**	551.00		625.00	753.00		
OLD ENGLISH COAL GRATE	VG4-**C	447.00		481.00	552.00		
ROYAL ENGLISH OAK DESIGNER*	BDGX4*	535.00		610.00	731.00	926.00	1228.00
	BDGX45-*	570.00		656.00	781.00	982.00	1291.00

D. G4 & G45 CLASSIC SERIES LOG SETS SIZES 18"- 42"

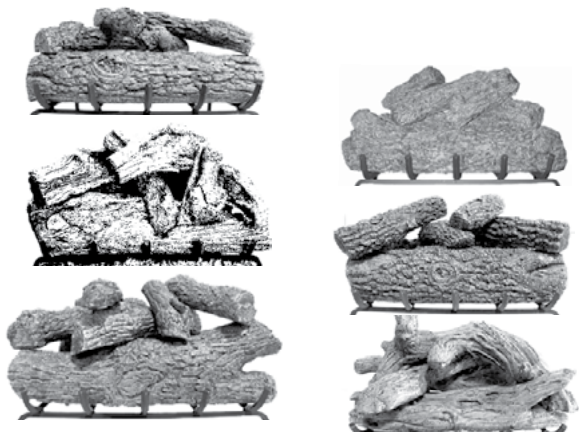

Style	No.	18"	20"	24"	30"	36" *	42" *
GOLDEN OAK	RG4-**	340.00	347.00	362.00	431.00	642.00	945.00
	RG45-**	374.00	381.00	408.00	482.00	698.00	1008.00
RUSTIC OAK	HRG4-**	340.00		362.00	431.00	642.00	945.00
	HRG45-**	374.00		408.00	482.00	698.00	1008.00
RUGGED OAK	RROG4-**	379.00		422.00	500.00		
	RROG45-**	413.00		468.00	551.00		
POST OAK	POG4-**	331.00	338.00	354.00	422.00		
	POG45-**	365.00	372.00	400.00	473.00		
ROYAL ENGLISH OAK*	BGX4-**	416.00		474.00	563.00	721.00	997.00
	BGX45-**	451.00		520.00	613.00	777.00	1060.00
COASTAL DRIFTWOOD	CDRG4-**	350.00		366.00	443.00	635.00	
	CDRG45-**	384.00		418.00	494.00	691.00	

For G45 Stainless Steel Burner pan add "SS" to the product number (CHDG45-24-SS) and add the amount from this table:	Size	W	X
	16"	66.00	297.00
	18"/20"	72.00	303.00
	24"	77.00	308.00
	30"	85.00	316.00
	36"	92.00	323.00
	42"	97.00	328.00
	48"	105.00	336.00
	60"	118.00	349.00
	W = Natural without Valve X = Natural or Propane with Valve (Also add a "N" for Natural or a "P" for Propane) Example: CHDG45-24N-SS		

A. G45 TRIPLE T BURNER CHARRED SERIES LOG SETS - SIZES 16" - 36"

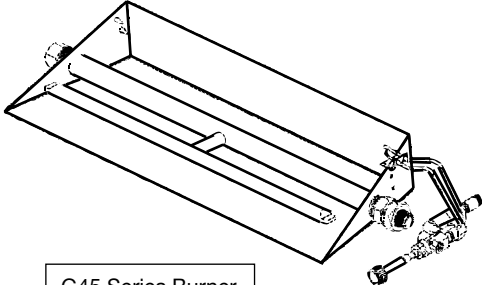

G45 Series Burner with SPK

Style	No.	16"	18"	24"	30"	36"
CHARRED OAK	CHDG45-**A	669. ⁰⁰	706. ⁰⁰	773. ⁰⁰	911. ⁰⁰	
	CHDG45**-11	966. ⁰⁰	1003. ⁰⁰	1070. ⁰⁰	1208. ⁰⁰	
	CHDG45**-15	1011. ⁰⁰	1048. ⁰⁰	1115. ⁰⁰	1253. ⁰⁰	
	CHDG45**-17	903. ⁰⁰	940. ⁰⁰	1007. ⁰⁰	1145. ⁰⁰	
	CHDG45**-01	1071. ⁰⁰	1108. ⁰⁰	1175. ⁰⁰	1313. ⁰⁰	
BURNT RUSTIC OAK	HCHRG45-**A	669. ⁰⁰	706. ⁰⁰	773. ⁰⁰	911. ⁰⁰	
	HCHRG45**-11	966. ⁰⁰	1003. ⁰⁰	1070. ⁰⁰	1208. ⁰⁰	
	HCHRG45**-15	1011. ⁰⁰	1048. ⁰⁰	1115. ⁰⁰	1253. ⁰⁰	
	HCHRG45**-17	903. ⁰⁰	940. ⁰⁰	1007. ⁰⁰	1145. ⁰⁰	
	HCHRG45**-01	1071. ⁰⁰	1108. ⁰⁰	1175. ⁰⁰	1313. ⁰⁰	
CHARRED SPLIT	CHSG45-**A		730. ⁰⁰	795. ⁰⁰	936. ⁰⁰	1164. ⁰⁰
	CHSG45**-11		1027. ⁰⁰	1092. ⁰⁰	1233. ⁰⁰	1461. ⁰⁰
	CHSG45**-15		1072. ⁰⁰	1137. ⁰⁰	1278. ⁰⁰	1506. ⁰⁰
	CHSG45**-17		964. ⁰⁰	1029. ⁰⁰	1170. ⁰⁰	1398. ⁰⁰
	CHSG45**-01		1132. ⁰⁰	1197. ⁰⁰	1338. ⁰⁰	1566. ⁰⁰
BURNT SPLIT OAK	HCHSG45-**A		730. ⁰⁰	795. ⁰⁰	936. ⁰⁰	
	HCHSG45**-11		1027. ⁰⁰	1092. ⁰⁰	1233. ⁰⁰	
	HCHSG45**-15		1072. ⁰⁰	1137. ⁰⁰	1278. ⁰⁰	
	HCHSG45**-17		964. ⁰⁰	1029. ⁰⁰	1170. ⁰⁰	
	HCHSG45**-01		1132. ⁰⁰	1197. ⁰⁰	1338. ⁰⁰	
CHARRED RUGGED SPLIT OAK	CHRRSOG45-**A		750. ⁰⁰	812. ⁰⁰	945. ⁰⁰	
	CHRRSOG45**-11		1047. ⁰⁰	1109. ⁰⁰	1242. ⁰⁰	
	CHRRSOG45**-15		1092. ⁰⁰	1154. ⁰⁰	1287. ⁰⁰	
	CHRRSOG45**-17		984. ⁰⁰	1046. ⁰⁰	1179. ⁰⁰	
	CHRRSOG45**-01		1152. ⁰⁰	1214. ⁰⁰	1347. ⁰⁰	
CHARRED AMERICAN OAK	CHAOG45-**A		780. ⁰⁰	848. ⁰⁰	991. ⁰⁰	
	CHAOG45**-11		1077. ⁰⁰	1145. ⁰⁰	1288. ⁰⁰	
	CHAOG45**-15		1122. ⁰⁰	1190. ⁰⁰	1333. ⁰⁰	
	CHAOG45**-17		1014. ⁰⁰	1082. ⁰⁰	1225. ⁰⁰	
	CHAOG45**-01		1182. ⁰⁰	1250. ⁰⁰	1393. ⁰⁰	
CHARRED CEDAR	CHCRG45-**A		777. ⁰⁰	845. ⁰⁰	980. ⁰⁰	
	CHCRG45**-11		1074. ⁰⁰	1142. ⁰⁰	1277. ⁰⁰	
	CHCRG45**-15		1119. ⁰⁰	1187. ⁰⁰	1322. ⁰⁰	
	CHCRG45**-17		1011. ⁰⁰	1079. ⁰⁰	1214. ⁰⁰	
	CHCRG45**-01		1179. ⁰⁰	1247. ⁰⁰	1382. ⁰⁰	
CHARRED RED OAK	CHREDG45-**A		777. ⁰⁰	845. ⁰⁰	980. ⁰⁰	
	CHREDG45**-11		1074. ⁰⁰	1142. ⁰⁰	1277. ⁰⁰	
	CHREDG45**-15		1119. ⁰⁰	1187. ⁰⁰	1322. ⁰⁰	
	CHREDG45**-17		1011. ⁰⁰	1079. ⁰⁰	1214. ⁰⁰	
	CHREDG45**-01		1179. ⁰⁰	1247. ⁰⁰	1382. ⁰⁰	
CHARRED FORREST	CHFG45-**A		754. ⁰⁰	824. ⁰⁰	969. ⁰⁰	
	CHFG45**-11		1051. ⁰⁰	1121. ⁰⁰	1259. ⁰⁰	
	CHFG45**-15		1096. ⁰⁰	1166. ⁰⁰	1304. ⁰⁰	
	CHFG45**-17		988. ⁰⁰	1058. ⁰⁰	1196. ⁰⁰	
	CHFG45**-01		1156. ⁰⁰	1226. ⁰⁰	1364. ⁰⁰	
CHARRED NORTHERN	CHNG45-**A		718. ⁰⁰	788. ⁰⁰	924. ⁰⁰	
	CHNG45**-11		1015. ⁰⁰	1085. ⁰⁰	1221. ⁰⁰	
	CHNG45**-15		1060. ⁰⁰	1130. ⁰⁰	1266. ⁰⁰	
	CHNG45**-17		942. ⁰⁰	1022. ⁰⁰	1158. ⁰⁰	
	CHNG45**-01		1120. ⁰⁰	1190. ⁰⁰	1326. ⁰⁰	
CHARRED OAK STACK	CHDSG45-**A		704. ⁰⁰	771. ⁰⁰	881. ⁰⁰	
	CHDSG45**-11		1001. ⁰⁰	1068. ⁰⁰	1178. ⁰⁰	
	CHDSG45**-15		1046. ⁰⁰	1113. ⁰⁰	1223. ⁰⁰	
	CHDSG45**-17		934. ⁰⁰	1005. ⁰⁰	1115. ⁰⁰	
	CHDSG45**-01		1106. ⁰⁰	1173. ⁰⁰	1283. ⁰⁰	

G45 Series Burner Systems are available in ANSI certified sets and include:

Gas Logs • Certified Burner with pre assembled Control Valve and Regulator • Custom Grate • Glowing Embers • Sand (natural) or Vermiculite (propane) • Log Locators • Connector Kit • Damper Clamp

Remote systems include basic Transmitter and Receiver

See Sections XI, XIII, XIV for components and accessories. For See Thru Sets see Section IX

Shipped for use with Natural Gas. Specify if for Propane Gas by adding a "P" to the model number (eg. CHDG45-24PA).

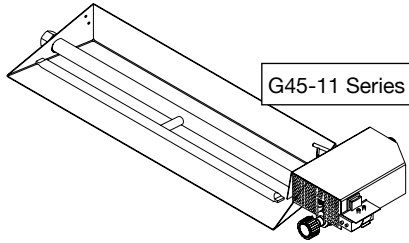

G45-11 Series Burner

B. G45 TRIPLE T BURNER CLASSIC SERIES LOG SETS SIZES 16" - 36"

Style	No.	16"	18"	20"	24"	30"	36"
GOLDEN OAK	RG45-**A	547. ⁰⁰	568. ⁰⁰	575. ⁰⁰	600. ⁰⁰	674. ⁰⁰	879. ⁰⁰
	RG45**-11	844. ⁰⁰	865. ⁰⁰	872. ⁰⁰	897. ⁰⁰	971. ⁰⁰	1176. ⁰⁰
	RG45**-15	889. ⁰⁰	910. ⁰⁰	917. ⁰⁰	942. ⁰⁰	1016. ⁰⁰	1221. ⁰⁰
	RG45**-17	781. ⁰⁰	802. ⁰⁰	809. ⁰⁰	834. ⁰⁰	908. ⁰⁰	1113. ⁰⁰
	RG45**-01	949. ⁰⁰	970. ⁰⁰	977. ⁰⁰	1002. ⁰⁰	1076. ⁰⁰	1281. ⁰⁰
RUSTIC OAK	HRG45-**A	547. ⁰⁰	568. ⁰⁰		600. ⁰⁰	674. ⁰⁰	879. ⁰⁰
	HRG45**-11	844. ⁰⁰	865. ⁰⁰		897. ⁰⁰	971. ⁰⁰	1176. ⁰⁰
	HRG45**-15	889. ⁰⁰	910. ⁰⁰		942. ⁰⁰	1016. ⁰⁰	1221. ⁰⁰
	HRG45**-17	781. ⁰⁰	802. ⁰⁰		834. ⁰⁰	908. ⁰⁰	1113. ⁰⁰
	HRG45**-01	949. ⁰⁰	970. ⁰⁰		1002. ⁰⁰	1076. ⁰⁰	1281. ⁰⁰
RUGGED OAK	RROG45-**A		607. ⁰⁰		660. ⁰⁰	743. ⁰⁰	
	RROG45**-11		904. ⁰⁰		957. ⁰⁰	1040. ⁰⁰	
	RROG45**-15		949. ⁰⁰		1002. ⁰⁰	1085. ⁰⁰	
	RROG45**-17		841. ⁰⁰		894. ⁰⁰	977. ⁰⁰	
	RROG45**-01		1009. ⁰⁰		1062. ⁰⁰	1145. ⁰⁰	
POST OAK	POG45-**A		559. ⁰⁰	566. ⁰⁰	592. ⁰⁰	665. ⁰⁰	
	POG45**-11		856. ⁰⁰	863. ⁰⁰	889. ⁰⁰	962. ⁰⁰	
	POG45**-15		901. ⁰⁰	908. ⁰⁰	934. ⁰⁰	1007. ⁰⁰	
	POG45**-17		793. ⁰⁰	800. ⁰⁰	826. ⁰⁰	899. ⁰⁰	
	POG45**-01		961. ⁰⁰	968. ⁰⁰	1012. ⁰⁰	1067. ⁰⁰	

C. G45 DESIGNER LOG SETS - SIZES 16"-36"

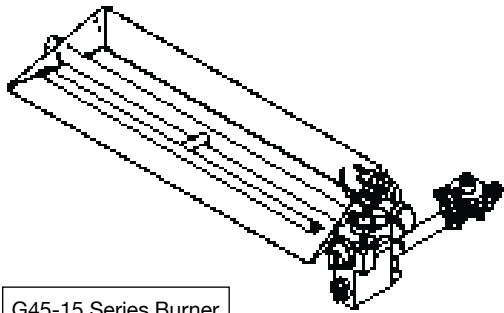

G45-15 Series Burner

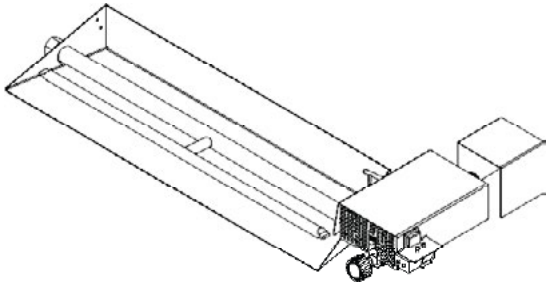

G45-17 Series Burner

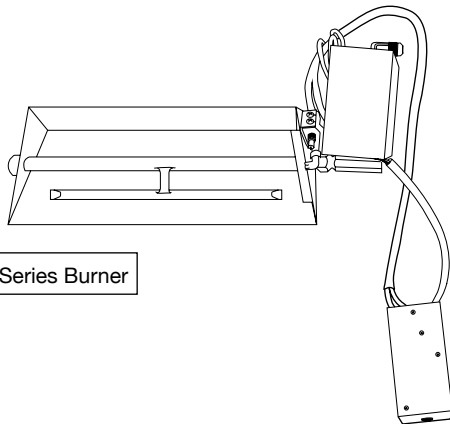

G45-01 Series Burner

Style	No.	16"	18"	20"	24"	30"	36"
GOLDEN OAK DESIGNER PLUS	RDPG45-**A	610. ⁰⁰	654. ⁰⁰	669. ⁰⁰	723. ⁰⁰	850. ⁰⁰	1084. ⁰⁰
	RDPG45-**11	907. ⁰⁰	951. ⁰⁰	966. ⁰⁰	1020. ⁰⁰	1147. ⁰⁰	1381. ⁰⁰
	RDPG45-**15	952. ⁰⁰	996. ⁰⁰	1011. ⁰⁰	1065. ⁰⁰	1192. ⁰⁰	1426. ⁰⁰
	RDPG45-**17	844. ⁰⁰	888. ⁰⁰	902. ⁰⁰	957. ⁰⁰	1084. ⁰⁰	1318. ⁰⁰
	RDPG45-**01	1012. ⁰⁰	1056. ⁰⁰	1071. ⁰⁰	1125. ⁰⁰	1252. ⁰⁰	1486. ⁰⁰
RUSTIC OAK DESIGNER	HRDG45-**A	610. ⁰⁰	646. ⁰⁰		713. ⁰⁰	829. ⁰⁰	1084. ⁰⁰
	HRDG45-**11	907. ⁰⁰	943. ⁰⁰		1010. ⁰⁰	1126. ⁰⁰	1381. ⁰⁰
	HRDG45-**15	952. ⁰⁰	988. ⁰⁰		1055. ⁰⁰	1171. ⁰⁰	1426. ⁰⁰
	HRDG45-**17	844. ⁰⁰	880. ⁰⁰		947. ⁰⁰	1063. ⁰⁰	1318. ⁰⁰
	HRDG45-**01	1012. ⁰⁰	1048. ⁰⁰		1115. ⁰⁰	1231. ⁰⁰	1486. ⁰⁰
FOREST OAK	FOG45-**A		686. ⁰⁰		739. ⁰⁰	835. ⁰⁰	
	FOG45-**11		983. ⁰⁰		1036. ⁰⁰	1132. ⁰⁰	
	FOG45-**15		1028. ⁰⁰		1081. ⁰⁰	1177. ⁰⁰	
	FOG45-**17		920. ⁰⁰		973. ⁰⁰	1069. ⁰⁰	
	FOG45-**01		1088. ⁰⁰		1141. ⁰⁰	1237. ⁰⁰	
AMERICAN OAK	AOG45-**A		737. ⁰⁰		805. ⁰⁰	925. ⁰⁰	
	AOG45-**11		1034. ⁰⁰		1102. ⁰⁰	1222. ⁰⁰	
	AOG45-**15		1079. ⁰⁰		1147. ⁰⁰	1267. ⁰⁰	
	AOG45-**01		971. ⁰⁰		1039. ⁰⁰	1159. ⁰⁰	
CEDAR	CRG45-**A		734. ⁰⁰		808. ⁰⁰	927. ⁰⁰	
	CRG45-**11		1031. ⁰⁰		1105. ⁰⁰	1224. ⁰⁰	
	CRG45-**15		1076. ⁰⁰		1150. ⁰⁰	1269. ⁰⁰	
	CRG45-**17		968. ⁰⁰		1042. ⁰⁰	1161. ⁰⁰	
	CRG45-**01		1136. ⁰⁰		1210. ⁰⁰	1329. ⁰⁰	
RED OAK	REDG45-**A		734. ⁰⁰		808. ⁰⁰	927. ⁰⁰	
	REDG45-**11		1031. ⁰⁰		1105. ⁰⁰	1224. ⁰⁰	
	REDG45-**15		1076. ⁰⁰		1150. ⁰⁰	1269. ⁰⁰	
	REDG45-**17		968. ⁰⁰		1042. ⁰⁰	1161. ⁰⁰	
	REDG45-**01		1136. ⁰⁰		1210. ⁰⁰	1329. ⁰⁰	
SPLIT OAK	SG45-**A		670. ⁰⁰	685. ⁰⁰	728. ⁰⁰	849. ⁰⁰	
	SG45-**11		967. ⁰⁰	982. ⁰⁰	1025. ⁰⁰	1146. ⁰⁰	
	SG45-**15		1012. ⁰⁰	1027. ⁰⁰	1070. ⁰⁰	1191. ⁰⁰	
	SG45-**17		904. ⁰⁰	919. ⁰⁰	962. ⁰⁰	1083. ⁰⁰	
	SG45-**01		1072. ⁰⁰	1087. ⁰⁰	1130. ⁰⁰	1251. ⁰⁰	
SPLIT OAK DESIGNER PLUS	SDPG45-**A		703. ⁰⁰	725. ⁰⁰	769. ⁰⁰	892. ⁰⁰	1118. ⁰⁰
	SDPG45-**11		1000. ⁰⁰	1022. ⁰⁰	1066. ⁰⁰	1189. ⁰⁰	1415. ⁰⁰
	SDPG45-**15		1045. ⁰⁰	1067. ⁰⁰	1111. ⁰⁰	1234. ⁰⁰	1460. ⁰⁰
	SDPG45-**17		937. ⁰⁰	959. ⁰⁰	1003. ⁰⁰	1126. ⁰⁰	1352. ⁰⁰
	SDPG45-**01		1105. ⁰⁰	1127. ⁰⁰	1171. ⁰⁰	1294. ⁰⁰	1520. ⁰⁰
RUGGED SPLIT OAK	RRSOG45-**A		725. ⁰⁰		785. ⁰⁰	887. ⁰⁰	
	RRSOG45-**11		1022. ⁰⁰		1082. ⁰⁰	1184. ⁰⁰	
	RRSOG45-**15		1067. ⁰⁰		1127. ⁰⁰	1229. ⁰⁰	
	RRSOG45-**17		959. ⁰⁰		1019. ⁰⁰	1121. ⁰⁰	
	RRSOG45-**01		1127. ⁰⁰		1187. ⁰⁰	1289. ⁰⁰	
WOODSTACK	WSG45-**A		760. ⁰⁰		824. ⁰⁰	952. ⁰⁰	
	WSG45-**11		1051. ⁰⁰		1121. ⁰⁰	1249. ⁰⁰	
	WSG45-**15		1102. ⁰⁰		1166. ⁰⁰	1294. ⁰⁰	
	WSG45-**17		994. ⁰⁰		1058. ⁰⁰	1186. ⁰⁰	
	WSG45-**01		1162. ⁰⁰		1226. ⁰⁰	1354. ⁰⁰	
WOODLAND OAK	WOG45-**A		647. ⁰⁰	654. ⁰⁰	702. ⁰⁰	807. ⁰⁰	
	WOG45-**11		944. ⁰⁰	951. ⁰⁰	999. ⁰⁰	1104. ⁰⁰	
	WOG45-**15		989. ⁰⁰	996. ⁰⁰	1044. ⁰⁰	1149. ⁰⁰	
	WOG45-**17		881. ⁰⁰	888. ⁰⁰	936. ⁰⁰	1041. ⁰⁰	
	WOG45-**01		1049. ⁰⁰	1056. ⁰⁰	1104. ⁰⁰	1209. ⁰⁰	
MOUNTAIN BIRCH	MBWG45-**A		722. ⁰⁰		780. ⁰⁰	873. ⁰⁰	
	MBWG45-**11		1019. ⁰⁰		1077. ⁰⁰	1170. ⁰⁰	
	MBWG45-**15		1064. ⁰⁰		1122. ⁰⁰	1215. ⁰⁰	
	MBWG45-**17		956. ⁰⁰		1014. ⁰⁰	1107. ⁰⁰	
	MBWG45-**01		1124. ⁰⁰		1182. ⁰⁰	1275. ⁰⁰	
WHITE BIRCH	WG45-**A		679. ⁰⁰		727. ⁰⁰	817. ⁰⁰	
	WG45-**11		976. ⁰⁰		1024. ⁰⁰	1114. ⁰⁰	
	WG45-**15		1021. ⁰⁰		1069. ⁰⁰	1159. ⁰⁰	
	WG45-**17		913. ⁰⁰		961. ⁰⁰	1051. ⁰⁰	
	WG45-**01		1081. ⁰⁰		1129. ⁰⁰	1219. ⁰⁰	
WESTERN CAMPFYRE	WCFG45-**A		745. ⁰⁰		817. ⁰⁰	945. ⁰⁰	
	WCFG45-**11		1042. ⁰⁰		1114. ⁰⁰	1242. ⁰⁰	
	WCFG45-**15		1087. ⁰⁰		1159. ⁰⁰	1287. ⁰⁰	
	WCF45-**17		979. ⁰⁰		1051. ⁰⁰	1179. ⁰⁰	
	WCFG45-**01		1147. ⁰⁰		1219. ⁰⁰	1347. ⁰⁰	

For G45 Stainless Steel Burner pan add "SS" to the product number (CHDG45-24-15-SS) and add the amount from this table:

Size	"A" Valve	11,15,17 or 01 Valve
16"	66. ⁰⁰	123. ⁰⁰
18/20"	72. ⁰⁰	129. ⁰⁰
24"	77. ⁰⁰	136. ⁰⁰
30"	85. ⁰⁰	144. ⁰⁰
36"	85. ⁰⁰	144. ⁰⁰

A. G46 CHARRED SERIES LOG SETS - SIZES 18" - 30"

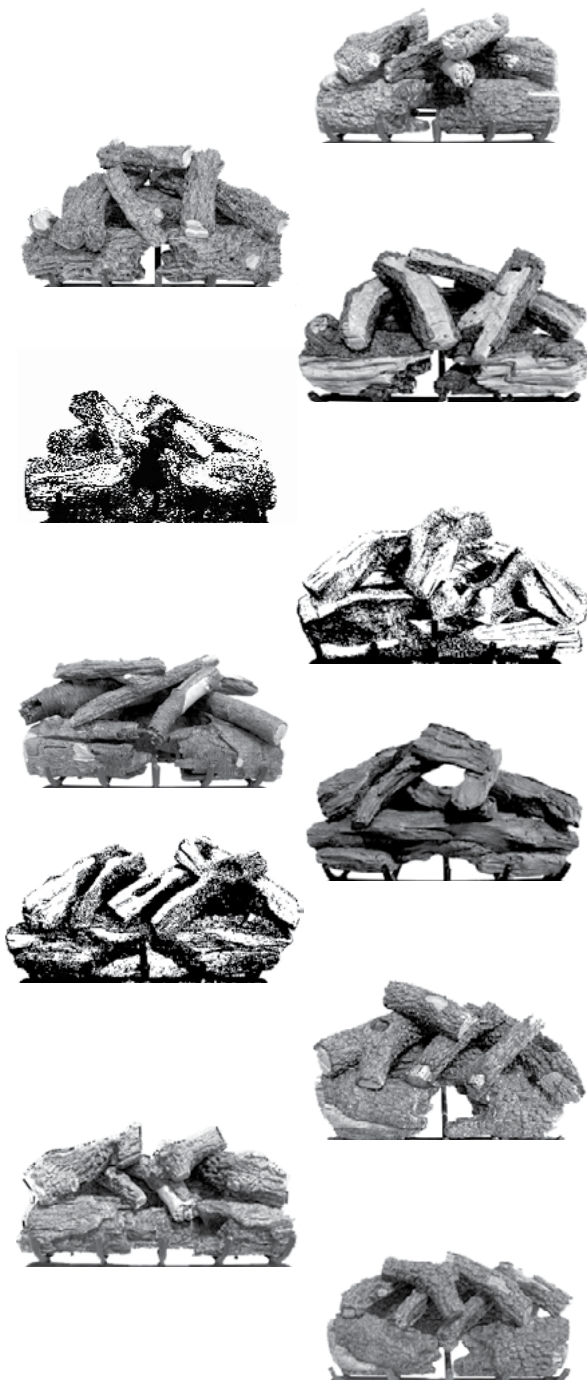

Style	No.	18"	24"	30"
CHARRED OAK	CHDG46-**	716. ⁰⁰	783. ⁰⁰	906. ⁰⁰
	CHDG46**-11	1013. ⁰⁰	1080. ⁰⁰	1203. ⁰⁰
	CHDG46**-15	1058. ⁰⁰	1125. ⁰⁰	1248. ⁰⁰
	CHDG46**-17	950. ⁰⁰	1017. ⁰⁰	1140. ⁰⁰
	CHDG46**-01	1118. ⁰⁰	1185. ⁰⁰	1308. ⁰⁰
BURNT RUSTIC OAK	HCHRG46-**	716. ⁰⁰	783. ⁰⁰	906. ⁰⁰
	HCHRG46**-11	1013. ⁰⁰	1080. ⁰⁰	1203. ⁰⁰
	HCHRG46**-15	1058. ⁰⁰	1125. ⁰⁰	1248. ⁰⁰
	HCHRG46**-17	950. ⁰⁰	1017. ⁰⁰	1140. ⁰⁰
	HCHRG46**-01	1118. ⁰⁰	1185. ⁰⁰	1308. ⁰⁰
CHARRED SPLIT	CHSG46-**	737. ⁰⁰	805. ⁰⁰	931. ⁰⁰
	CHSG46**-11	1034. ⁰⁰	1102. ⁰⁰	1228. ⁰⁰
	CHSG46**-15	1079. ⁰⁰	1147. ⁰⁰	1273. ⁰⁰
	CHSG46**-17	971. ⁰⁰	1039. ⁰⁰	1165. ⁰⁰
	CHSG46**-01	1139. ⁰⁰	1207. ⁰⁰	1333. ⁰⁰
BURNT SPLIT OAK	HCHSG46-**	737. ⁰⁰	805. ⁰⁰	931. ⁰⁰
	HCHSG46**-11	1034. ⁰⁰	1102. ⁰⁰	1228. ⁰⁰
	HCHSG46**-15	1079. ⁰⁰	1147. ⁰⁰	1273. ⁰⁰
	HCHSG46**-17	971. ⁰⁰	1039. ⁰⁰	1165. ⁰⁰
	HCHSG46**-01	1139. ⁰⁰	1207. ⁰⁰	1333. ⁰⁰
CHARRED RUGGED SPLIT OAK	CHRRSOG46-**	757. ⁰⁰	822. ⁰⁰	940. ⁰⁰
	CHRRSOG46**-11	1054. ⁰⁰	1119. ⁰⁰	1237. ⁰⁰
	CHRRSOG46**-15	1099. ⁰⁰	1164. ⁰⁰	1282. ⁰⁰
	CHRRSOG46**-17	991. ⁰⁰	1056. ⁰⁰	1174. ⁰⁰
	CHRRSOG46**-01	1159. ⁰⁰	1224. ⁰⁰	1342. ⁰⁰
CHARRED AMERICAN OAK	CHAOG46-**	787. ⁰⁰	858. ⁰⁰	986. ⁰⁰
	CHAOG46**-11	1084. ⁰⁰	1155. ⁰⁰	1283. ⁰⁰
	CHAOG46**-15	1129. ⁰⁰	1200. ⁰⁰	1328. ⁰⁰
	CHAOG46**-17	1021. ⁰⁰	1092. ⁰⁰	1220. ⁰⁰
	CHAOG46**-01	1189. ⁰⁰	1260. ⁰⁰	1388. ⁰⁰
CHARRED CEDAR	CHCRG46-**	784. ⁰⁰	855. ⁰⁰	975. ⁰⁰
	CHCRG46**-11	1081. ⁰⁰	1152. ⁰⁰	1272. ⁰⁰
	CHCRG46**-15	1126. ⁰⁰	1197. ⁰⁰	1317. ⁰⁰
	CHCRG46**-17	1018. ⁰⁰	1089. ⁰⁰	1209. ⁰⁰
	CHCRG46**-01	1186. ⁰⁰	1257. ⁰⁰	1377. ⁰⁰
CHARRED RED OAK	CHREDG46-**	784. ⁰⁰	855. ⁰⁰	975. ⁰⁰
	CHREDG46**-11	1081. ⁰⁰	1152. ⁰⁰	1272. ⁰⁰
	CHREDG46**-15	1126. ⁰⁰	1197. ⁰⁰	1317. ⁰⁰
	CHREDG46**-17	1018. ⁰⁰	1089. ⁰⁰	1209. ⁰⁰
	CHREDG46**-01	1186. ⁰⁰	1257. ⁰⁰	1377. ⁰⁰
CHARRED FOREST	CHFG46-**	761. ⁰⁰	834. ⁰⁰	957. ⁰⁰
	CHFG46**-11	1058. ⁰⁰	1131. ⁰⁰	1254. ⁰⁰
	CHFG46**-15	1103. ⁰⁰	1176. ⁰⁰	1299. ⁰⁰
	CHFG46**-17	995. ⁰⁰	1068. ⁰⁰	1191. ⁰⁰
	CHFG46**-01	1163. ⁰⁰	1236. ⁰⁰	1359. ⁰⁰
CHARRED NORTHERN	CHNG46-**	725. ⁰⁰	798. ⁰⁰	919. ⁰⁰
	CHNG46**-11	1022. ⁰⁰	1095. ⁰⁰	1216. ⁰⁰
	CHNG46**-15	1067. ⁰⁰	1140. ⁰⁰	1261. ⁰⁰
	CHNG46**-17	959. ⁰⁰	1032. ⁰⁰	1153. ⁰⁰
	CHNG46**-01	1127. ⁰⁰	1200. ⁰⁰	1321. ⁰⁰
CHARRED OAK STACK	CHDSG46-**	711. ⁰⁰	781. ⁰⁰	876. ⁰⁰
	CHDSG46**-11	1008. ⁰⁰	1078. ⁰⁰	1173. ⁰⁰
	CHDSG46**-15	1053. ⁰⁰	1123. ⁰⁰	1218. ⁰⁰
	CHDSG46**-17	945. ⁰⁰	1015. ⁰⁰	1110. ⁰⁰
	CHDSG46**-01	1113. ⁰⁰	1183. ⁰⁰	1278. ⁰⁰

B. G46 CLASSIC SERIES LOG SETS

SIZES 18" - 30"

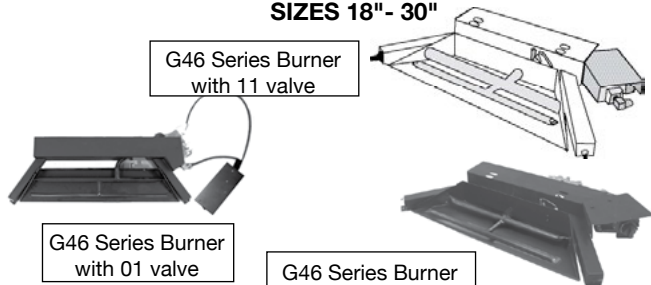

G46 Series Burner with 11 valve

G46 Series Burner with 01 valve

G46 Series Burner

G46 Series Gas Log Sets are ANSI Certified and Include:
 Gas Logs • Certified Burner with pre Assembled Control Valve & regulator
 • Custom Grate • Glowing Embers • Sand(natural) or Vermiculite(LP) • Log Locators • Connector Kit • Piezo ignitor • Damper Clamp

See Sections XI, XIII, XIV for component and accessories.

Shipped for use with Natural Gas. Specify if for Propane Gas by adding a "P" to the model number (eg. CHDG46-24P).

Remote systems include basic Transmitter and Receiver

Style	No.	18"	20"	24"	30"
GOLDEN OAK	RG46-**	575. ⁰⁰	582. ⁰⁰	610. ⁰⁰	669. ⁰⁰
	RG46**-11	872. ⁰⁰	879. ⁰⁰	907. ⁰⁰	966. ⁰⁰
	RG46**-15	917. ⁰⁰	924. ⁰⁰	952. ⁰⁰	1011. ⁰⁰
	RG46**-17	809. ⁰⁰	816. ⁰⁰	844. ⁰⁰	903. ⁰⁰
	RG46**-01	977. ⁰⁰	984. ⁰⁰	1012. ⁰⁰	1071. ⁰⁰
RUSTIC OAK	HRG46-**	575. ⁰⁰		610. ⁰⁰	669. ⁰⁰
	HRG46**-11	872. ⁰⁰		907. ⁰⁰	966. ⁰⁰
	HRG46**-15	917. ⁰⁰		952. ⁰⁰	1011. ⁰⁰
	HRG46**-17	809. ⁰⁰		844. ⁰⁰	903. ⁰⁰
	HRG46**-01	977. ⁰⁰		1012. ⁰⁰	1071. ⁰⁰
RUGGED OAK	RROG46-**	614. ⁰⁰		670. ⁰⁰	738. ⁰⁰
	RROG46**-11	911. ⁰⁰		967. ⁰⁰	1035. ⁰⁰
	RROG46**-15	956. ⁰⁰		1012. ⁰⁰	1080. ⁰⁰
	RROG46**-17	848. ⁰⁰		904. ⁰⁰	972. ⁰⁰
	RROG46**-01	1016. ⁰⁰		1072. ⁰⁰	1140. ⁰⁰
POST OAK	POG46-**	566. ⁰⁰	573. ⁰⁰	602. ⁰⁰	660. ⁰⁰
	POG46**-11	863. ⁰⁰	870. ⁰⁰	899. ⁰⁰	957. ⁰⁰
	POG46**-15	908. ⁰⁰	915. ⁰⁰	944. ⁰⁰	1002. ⁰⁰
	POG46**-17	800. ⁰⁰	807. ⁰⁰	836. ⁰⁰	894. ⁰⁰
	POG46**-01	968. ⁰⁰	975. ⁰⁰	1004. ⁰⁰	1062. ⁰⁰

C. G46 DESIGNER SERIES LOG SETS SIZES 18"-30"



Style	No.	18"	20"	24"	30"
GOLDEN OAK DESIGNER PLUS	RDPG46-**	661.00	676.00	733.00	845.00
	RDPG46**-11	958.00	973.00	1030.00	1142.00
	RDPG46**-15	1003.00	1018.00	1075.00	1187.00
	RDPG46**-17	895.00	910.00	967.00	1079.00
	RDPG46**-01	1063.00	1078.00	1135.00	1247.00
RUSTIC OAK DESIGNER	HRDG46-**	653.00		723.00	824.00
	HRDG46**-11	950.00		1020.00	1121.00
	HRDG46**-15	995.00		1065.00	1166.00
	HRDG46**-17	887.00		957.00	1058.00
	HRDG46**-01	1055.00		1125.00	1226.00
FOREST OAK	FOG46-**	693.00		749.00	830.00
	FOG46**-11	990.00		1046.00	1127.00
	FOG46**-15	1035.00		1091.00	1172.00
	FOG46**-17	927.00		983.00	1064.00
	FOG46**-01	1095.00		1151.00	1232.00
AMERICAN OAK	AOG46-**	744.00		815.00	920.00
	AOG46**-11	1041.00		1112.00	1217.00
	AOG46**-15	1086.00		1157.00	1262.00
	AOG46**-17	978.00		1042.00	1154.00
	AOG46**-01	1146.00		1217.00	1322.00
CEDAR	CRG46-**	741.00		818.00	922.00
	CRG46**-11	1038.00		1115.00	1219.00
	CRG46**-15	1083.00		1160.00	1264.00
	CRG46**-17	975.00		1052.00	1156.00
	CRG46**-01	1143.00		1220.00	1324.00
RED OAK	REDG46-**	741.00		818.00	922.00
	REDG46**-11	1038.00		1115.00	1219.00
	REDG46**-15	1083.00		1160.00	1264.00
	REDG46**-17	975.00		1052.00	1156.00
	REDG46**-01	1143.00		1220.00	1324.00
SPLIT OAK	SG46-**	677.00	692.00	738.00	844.00
	SG46**-11	974.00	989.00	1035.00	1141.00
	SG46**-15	1019.00	1034.00	1080.00	1186.00
	SG46**-17	911.00	926.00	972.00	1078.00
	SG46**-01	1079.00	1094.00	1140.00	1246.00
SPLIT OAK DESIGNER PLUS	SDPG46-**	710.00	734.00	779.00	887.00
	SDPG46**-11	1007.00	1031.00	1076.00	1184.00
	SDPG46**-15	1052.00	1076.00	1121.00	1229.00
	SDPG46**-17	944.00	968.00	1013.00	1121.00
	SDPG46**-01	1112.00	1136.00	1181.00	1289.00
RUGGED SPLIT OAK	RRSOG46-**	732.00		795.00	882.00
	RRSOG46**-11	1029.00		1092.00	1179.00
	RRSOG46**-15	1074.00		1137.00	1224.00
	RRSOG46**-17	966.00		1029.00	1116.00
	RRSOG46**-01	1134.00		1197.00	1284.00
WOODSTACK	WSG46-**	767.00		834.00	947.00
	WSG46**-11	1064.00		1131.00	1244.00
	WSG46**-15	1109.00		1176.00	1289.00
	WSG46**-17	1001.00		1068.00	1181.00
	WSG46**-01	1169.00		1236.00	1349.00
WOODLAND OAK	WOG46-**	654.00	661.00	712.00	802.00
	WOG46**-11	951.00	958.00	1009.00	1049.00
	WOG46**-15	996.00	1003.00	1054.00	1144.00
	WOG46**-17	888.00	895.00	946.00	1036.00
	WOG46**-01	1056.00	1063.00	1114.00	1204.00
MOUNTAIN BIRCH	MBWG46-**	729.00		790.00	868.00
	MBWG46**-11	1026.00		1087.00	1165.00
	MBWG46**-15	1071.00		1132.00	1210.00
	MBWG46**-17	963.00		1024.00	1102.00
	MBWG46**-01	1131.00		1192.00	1270.00
WHITE BIRCH	WG46-**	686.00		737.00	812.00
	WG46**-11	983.00		1034.00	1109.00
	WG46**-15	1028.00		1079.00	1154.00
	WG46**-17	920.00		971.00	1046.00
	WG46**-01	1088.00		1139.00	1214.00
WESTERN CAMPFIRE	WCFG46-**	752.00		827.00	940.00
	WCFG46**-11	1049.00		1124.00	1237.00
	WCFG46**-15	1094.00		1169.00	1282.00
	WCFG46**-17	986.00		1061.00	1174.00
	WCFG46**-01	1154.00		1229.00	1342.00
SPLIT OAK (low set logs)	S6G46-**	675.00	691.00	736.00	805.00
	S6G46**-11	972.00	988.00	1033.00	1102.00
	S6G46**-15	1017.00	1033.00	1078.00	1147.00
	S6G46**-17	909.00	925.00	970.00	1039.00
	S6G46**-01	1077.00	1093.00	1138.00	1207.00



G46 Series Burner with 17 valve

A. G4 & G45 CHARRED SERIES SEE THRU LOG SETS SIZES 16"- 42" (See section D. below for 12"-19" and 48"-60" sets)

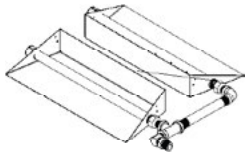

G4 See Thru Burner

Style	No.	16"	18"	24"	30"	36" *	42" *
CHARRED OAK	CHDG4-2-**	559. ⁰⁰	616. ⁰⁰	701. ⁰⁰	845. ⁰⁰		
	CHDG45-2-**	544. ⁰⁰	600. ⁰⁰	681. ⁰⁰	822. ⁰⁰		
CHARRED RUGGED SPLIT OAK	CHRRSOG4-2-**		654. ⁰⁰	749. ⁰⁰	880. ⁰⁰		
	CHRRSOG45-2**		638. ⁰⁰	729. ⁰⁰	857. ⁰⁰		
CHARRED AMERICAN OAK	CHAOG4-2-**		687. ⁰⁰	779. ⁰⁰	936. ⁰⁰		
	CHAOG45-2-**		671. ⁰⁰	759. ⁰⁰	913. ⁰⁰		
CHARRED ROYAL ENGLISH OAK*	CHBGX4-2-**		739. ⁰⁰	839. ⁰⁰	1000. ⁰⁰	1261. ⁰⁰	1641. ⁰⁰
	CHBGX45-2-**		723. ⁰⁰	819. ⁰⁰	979. ⁰⁰	1239. ⁰⁰	1623. ⁰⁰

G4 & G45 SERIES GLOWING EMBER GAS LOG SETS are Listed up to 30" and include:
 • Gas Logs • Glowing Ember See Thru Burner • Custom Grate • Glowing Embers • Sand or Vermiculite • Burner Clips • Damper Clamp • Connector Kit
 See Sections XI, XII, XIII, XIV for component parts and accessories.
 Shipped for use with Natural Gas - Specify if for Propane Gas by adding a "P" to the product number (RG4-24P), and add \$142.⁰⁰ for required SPK-26.
 * = Heavy Duty Grate
 For G45 See-Thru Stainless Steel Burner Pan add "SS" to the product number (CHDG45-2-**-SS) and add the amount from this table:
 W = Natural without Valve X = Natural or Propane with Valve (Also add "N" for Natural or "P" for propane)

Size	W	X
16"	76. ⁰⁰	307. ⁰⁰
18/20"	86. ⁰⁰	317. ⁰⁰
24"	96. ⁰⁰	327. ⁰⁰
30"	105. ⁰⁰	336. ⁰⁰
36"	116. ⁰⁰	347. ⁰⁰
42"	126. ⁰⁰	357. ⁰⁰
48"	136. ⁰⁰	367. ⁰⁰
60"	156. ⁰⁰	387. ⁰⁰

B. G4 & G45 DESIGNER SERIES SEE THRU LOG SETS SIZES 18"-42"

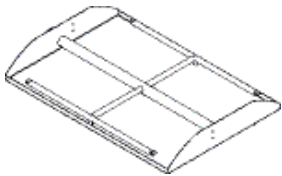

G45 See Thru Burner

Style	No.	18"	20"	24"	30"	36" *	42" *
GOLDEN OAK DESIGNER PLUS	RDPG4-2-**	539. ⁰⁰	557. ⁰⁰	644. ⁰⁰	773. ⁰⁰	1132. ⁰⁰	1346. ⁰⁰
	RDPG45-2-**	523. ⁰⁰	541. ⁰⁰	624. ⁰⁰	750. ⁰⁰	1110. ⁰⁰	1328. ⁰⁰
AMERICAN OAK	AOG4-2-**	627. ⁰⁰		712. ⁰⁰	860. ⁰⁰		
	AOG45-2-**	611. ⁰⁰		692. ⁰⁰	837. ⁰⁰		
SPLIT OAK DESIGNER PLUS	SDPG4-2-**	598. ⁰⁰	621. ⁰⁰	681. ⁰⁰	823. ⁰⁰	1158. ⁰⁰	
	SDPG45-2-**	582. ⁰⁰	605. ⁰⁰	661. ⁰⁰	800. ⁰⁰	1136. ⁰⁰	
RUGGED SPLIT OAK	RRSOG4-2-**	620. ⁰⁰		694. ⁰⁰	807. ⁰⁰		
	RRSOG45-2-**	604. ⁰⁰		674. ⁰⁰	784. ⁰⁰		
MOUNTAIN BIRCH	MBWG4-2-**	623. ⁰⁰		281. ⁰⁰	792. ⁰⁰		
	MBWG45-2-**	607. ⁰⁰		661. ⁰⁰	769. ⁰⁰		

C. G4 & G45 CLASSIC SERIES SEE THRU LOG SETS SIZES 18"-42"

Style	No.	18"	20"	24"	30"	36" *	42" *
GOLDEN OAK	RG4-2-**	445. ⁰⁰	453. ⁰⁰	491. ⁰⁰	577. ⁰⁰	888. ⁰⁰	1200. ⁰⁰
	RG45-2-**	429. ⁰⁰	437. ⁰⁰	471. ⁰⁰	554. ⁰⁰	866. ⁰⁰	1182. ⁰⁰

D. G4 & G45 SPECIAL SIZED DESIGNER & CLASSIC SEE-THRU SIZES 12"-19", 48"-60"

Style	No.	12"	16"	19"	48"*	60" *
GOLDEN OAK DESIGNER PLUS	RDPG4-2-**	424. ⁰⁰	473. ⁰⁰	497. ⁰⁰	1561. ⁰⁰	1795. ⁰⁰
	RDPG45-2-**		458. ⁰⁰	504. ⁰⁰	1549. ⁰⁰	1783. ⁰⁰
GOLDEN OAK	RG4-2-**	365. ⁰⁰	406. ⁰⁰	413. ⁰⁰		
	RG45-2-**		391. ⁰⁰	398. ⁰⁰		

A. G45 TRIPLE T BURNER CHARRED SERIES SEE THRU LOG SETS - SIZES 18" - 30"

G45 Series Burner Systems are available in ANSI certified sets and include:

See Thru Gas Logs • Certified See Thru Burner with pre assembled Control Valve and Regulator • Custom Grate • Glowing Embers • Sand (natural) or Vermiculite (propane) • Log Locators • Connector Kit • Damper Clamp

Remote systems include basic Transmitter and Receiver

See Sections XI, XIII, XIV for components and accessories.

Shipped for use with Natural Gas. Specify if for Propane Gas by adding a "P" to the model number (eg. CHDG45-24PA).

Style	No.	18"	24"	30"
CHARRED OAK	CHDG45-2-**-A	794. ⁰⁰	874. ⁰⁰	1015. ⁰⁰
	CHDG45-2-**-11	1091. ⁰⁰	1171. ⁰⁰	1312. ⁰⁰
	CHDG45-2-**-15	1136. ⁰⁰	1216. ⁰⁰	1357. ⁰⁰
	CHDG45-2-**-17	1024. ⁰⁰	1078. ⁰⁰	1249. ⁰⁰
	CHDG45-2-**-01	1196. ⁰⁰	1276. ⁰⁰	1417. ⁰⁰
CHARRED RUGGED SPLIT OAK	CHRRSOG45-2-**-A	832. ⁰⁰	922. ⁰⁰	1050. ⁰⁰
	CHRRSOG45-2-**-11	1129. ⁰⁰	1219. ⁰⁰	1347. ⁰⁰
	CHRRSOG45-2-**-15	1174. ⁰⁰	1264. ⁰⁰	1392. ⁰⁰
	CHRRSOG45-2-**-17	1066. ⁰⁰	1156. ⁰⁰	1284. ⁰⁰
	CHRRSOG45-2-**-01	1234. ⁰⁰	1324. ⁰⁰	1452. ⁰⁰
CHARRED AMERICAN OAK	CHAOG45-2-**-A	865. ⁰⁰	952. ⁰⁰	1106. ⁰⁰
	CHAOG45-2-**-11	1162. ⁰⁰	1249. ⁰⁰	1403. ⁰⁰
	CHAOG45-2-**-15	1207. ⁰⁰	1294. ⁰⁰	1448. ⁰⁰
	CHAOG45-2-**-17	1099. ⁰⁰	1186. ⁰⁰	1340. ⁰⁰
	CHAOG45-2-**-01	1267. ⁰⁰	1354. ⁰⁰	1508. ⁰⁰

B. G45 TRIPLE T DESIGNER SERIES SEE THRU LOG SETS SIZES 18"-30"

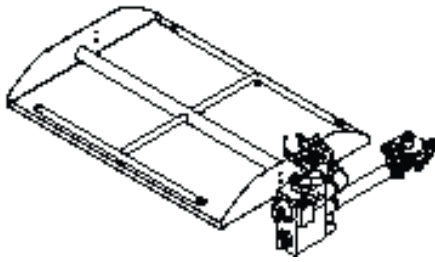

G45 Series ANSI Certified See-Thru Burner

Style	No.	18"	20"	24"	30"
GOLDEN OAK DESIGNER PLUS	RDPG45-2-**-A	717. ⁰⁰	735. ⁰⁰	817. ⁰⁰	943. ⁰⁰
	RDPG45-2-**-11	1014. ⁰⁰	1032. ⁰⁰	1114. ⁰⁰	1240. ⁰⁰
	RDPG45-2-**-15	1059. ⁰⁰	1077. ⁰⁰	1159. ⁰⁰	1285. ⁰⁰
	RDPG45-2-**-17	951. ⁰⁰	969. ⁰⁰	1051. ⁰⁰	1177. ⁰⁰
	RDPG45-2-**-01	1119. ⁰⁰	1137. ⁰⁰	1219. ⁰⁰	1345. ⁰⁰
AMERICAN OAK	AOG45-2-**-A	805. ⁰⁰		885. ⁰⁰	1030. ⁰⁰
	AOG45-2-**-11	1102. ⁰⁰		1182. ⁰⁰	1327. ⁰⁰
	AOG45-2-**-15	1147. ⁰⁰		1227. ⁰⁰	1372. ⁰⁰
	AOG45-2-**-17	1039. ⁰⁰		1119. ⁰⁰	1264. ⁰⁰
	AOG45-2-**-01	1207. ⁰⁰		1287. ⁰⁰	1432. ⁰⁰
SPLIT OAK DESIGNER PLUS	SDPG45-2-**-A	776. ⁰⁰	799. ⁰⁰	854. ⁰⁰	993. ⁰⁰
	SDPG45-2-**-11	1073. ⁰⁰	1096. ⁰⁰	1151. ⁰⁰	1290. ⁰⁰
	SDPG45-2-**-15	1118. ⁰⁰	1141. ⁰⁰	1196. ⁰⁰	1335. ⁰⁰
	SDPG45-2-**-17	1010. ⁰⁰	1033. ⁰⁰	1088. ⁰⁰	1227. ⁰⁰
	SDPG45-2-**-01	1175. ⁰⁰	1201. ⁰⁰	1256. ⁰⁰	1395. ⁰⁰
RUGGED SPLIT OAK	RRSOG45-2-**-A	798. ⁰⁰		867. ⁰⁰	977. ⁰⁰
	RRSOG45-2-**-11	1095. ⁰⁰		1164. ⁰⁰	1274. ⁰⁰
	RRSOG45-2-**-15	1140. ⁰⁰		1209. ⁰⁰	1319. ⁰⁰
	RRSOG45-2-**-17	1032. ⁰⁰		1101. ⁰⁰	1211. ⁰⁰
	RRSOG45-2-**-01	1200. ⁰⁰		1269. ⁰⁰	1379. ⁰⁰

C. G45 TRIPLE T BURNER CLASSIC SERIES SEE THRU LOG SETS SIZES 18" - 30"

For G45 See-Thru Stainless Steel ANSI Certified Burner pan add "SS" to the product number (CHDG45-2-17-SS) and add the amount from this table:

Size	"A" Valve	11,15,17, 01 Valve
18/20"	86. ⁰⁰	143. ⁰⁰
24"	96. ⁰⁰	154. ⁰⁰
30"	105. ⁰⁰	163. ⁰⁰

Style	No.	18"	20"	24"	30"
GOLDEN OAK	RG45-2-**-A	623. ⁰⁰	631. ⁰⁰	664. ⁰⁰	747. ⁰⁰
	RG45-2-**-11	920. ⁰⁰	928. ⁰⁰	961. ⁰⁰	1044. ⁰⁰
	RG45-2-**-15	965. ⁰⁰	973. ⁰⁰	1006. ⁰⁰	1089. ⁰⁰
	RG45-2-**-17	857. ⁰⁰	865. ⁰⁰	898. ⁰⁰	981. ⁰⁰
	RG45-2-**-01	1025. ⁰⁰	1033. ⁰⁰	1066. ⁰⁰	1149. ⁰⁰

A. CHARRED EVERGREEN OAK & RADIANT FYRE BURNER

NEW!

Style	Fireplace	No.	18/20"	24"	30"
CHARRED EVERGREEN	Electronic variable valve with remote	ENOG52-**-2VA	1501. ⁰⁰	1590. ⁰⁰	1678. ⁰⁰
	Manual valve	ENOG52-**-A	1154. ⁰⁰	1243. ⁰⁰	1331. ⁰⁰
	Match Lit without valve	ENOG52-** (Natural Gas Only)	970. ⁰⁰	1059. ⁰⁰	1147. ⁰⁰

Includes:

• Specially formulated, hand-crafted Charred Evergreen Oak Logs • Advanced Radiant Fyre Burner System • Exclusive radiant booster grid • Custom grate • Platinum Embers • Glowing Embers • Sand (NAT) or Vermiculite (LP) • Connector Kit & Damper Clamp • Choice of pre-assembled electronic variable control with remote, pre-assembled manual pilot kit, or match-lit system (natural gas only)

Shipped for use with Natural Gas - Specify if for Propane Gas by adding a "P" to the product number (eg. ENOG52-24-2VPA).

B. G52 RADIANT FYRE BURNER SYSTEM ONLY

No.	Fireplace	18/20"	24/30"
G52-**-2VA	Electronic variable valve with remote	1085. ⁰⁰	1130. ⁰⁰
G52-**-A	Manual valve	738. ⁰⁰	783. ⁰⁰
G52-** (Natural Gas Only)	Match Lit without valve	554. ⁰⁰	599. ⁰⁰



C. CHARRED EVERGREEN LOGS ONLY

No.	18"	24"	30"
ENO-**	416. ⁰⁰	460. ⁰⁰	548. ⁰⁰

Includes:

• Specially designed Massive Logs • Custom Grate • Raised EPIC Burner with pre-assembled Remote Control Safety Valve • Connector Kit • Damper Clamp • Remote Transmitter and Receiver

Shipped for use with Natural Gas - Specify if for Propane Gas by adding a "P" to the product number (eg. MPEC-60-10P). Add \$142.⁰⁰ for EC-**-P or EC-2-**-P

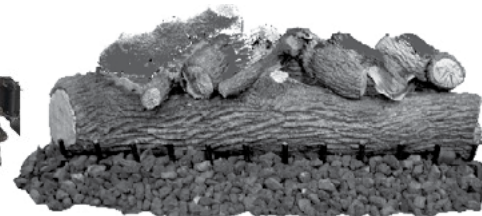
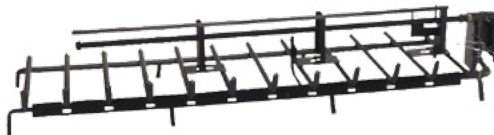

A. MAMMOTH PINE & EPIC BURNER

Style	Fireplace	No.	24"	30"	36"	48"	60"
MAMMOTH PINE	Oversized	MPEC-**-10	1258. ⁰⁰	1400. ⁰⁰	1592. ⁰⁰	2113. ⁰⁰	2343. ⁰⁰
	Oversized See-Thru	MPEC-2-**-10	1426. ⁰⁰	1633. ⁰⁰	1905. ⁰⁰	2418. ⁰⁰	2643. ⁰⁰
	Without Valve or control	MPEC-**	858. ⁰⁰	1000. ⁰⁰	1192. ⁰⁰	1713. ⁰⁰	1943. ⁰⁰
	Without valve See-Thru	MPEC-2-**	1026. ⁰⁰	1233. ⁰⁰	1505. ⁰⁰	2018. ⁰⁰	2243. ⁰⁰

B. EPIC BURNER SYSTEM ONLY

No.	24"	30"	36"	48"	60"
EC-**-10	806. ⁰⁰	849. ⁰⁰	901. ⁰⁰	1047. ⁰⁰	1111. ⁰⁰
Weight	40#	45#	60#	125#	140#
EC-2-**-10	901. ⁰⁰	992. ⁰⁰	1088. ⁰⁰	1298. ⁰⁰	1327. ⁰⁰
Weight	43#	48#	65#	130#	145#
EC-**	406. ⁰⁰	449. ⁰⁰	501. ⁰⁰	647. ⁰⁰	711. ⁰⁰
Weight	37#	42#	57#	122#	137#
EC-2-**	501. ⁰⁰	592. ⁰⁰	688. ⁰⁰	898. ⁰⁰	927. ⁰⁰
Weight	40#	45#	62#	127#	142#

C. MAMMOTH LOGS ONLY

No.	24"	30"	36"	48"	60"
MP-**	452. ⁰⁰	551. ⁰⁰	691. ⁰⁰	1066. ⁰⁰	1232. ⁰⁰
Weight	105#	170#	301#	515#	610#
MP-2-**	525. ⁰⁰	641. ⁰⁰	817. ⁰⁰	1120. ⁰⁰	1316. ⁰⁰
Weight	135#	195#	345#	550#	645#

NEW!
NEW!

NO.	DESCRIPTION	PRICE
SPK-26	Safety Pilot Kit (Low Profile) with removable knob handle	142. ⁰⁰
SPK-20	Safety Pilot Kit with removable knob handle	199. ⁰⁰
APK-10/APK-10P	Automatic Pilot Kit, w/ basic transmitter & receiver (High Capacity)	599. ⁰⁰
APK-11/APK-11P	Automatic Pilot Kit, w/ basic transmitter & receiver	447. ⁰⁰
APK-15/APK-15P	Automatic Pilot Kit, w/ basic transmitter & receiver, variable flame height	487. ⁰⁰
APK-17/APK-17P	Automatic Pilot Kit, w/ basic transmitter & receiver, variable flame height	382. ⁰⁰
EPK-1/EPK-1P	Electronic Pilot Kit, w/ basic transmitter & receiver, w/ non-standing Pilot	527. ⁰⁰
EPK-1M-AD/EPK-1M-AD/LP	Electronic Pilot Kit w/ Adaptor Plug and Mounting Bracket	490. ⁰⁰
EPK-2V-TR/EPK-2VP-TR	Electronic Pilot Kit w/ Variable Transmitter, Receiver, and Transformer	663. ⁰⁰
EPK-3V-TR/EPK-3VP-TR	Electronic Pilot Kit w/ Variable Transmitter, Receiver, and Transformer (High Capacity)	753. ⁰⁰
EPK-05/EPK-05P	Electronic Pilot w/ Hot Surface Ignition and Smart Valve	1513. ⁰⁰
AV-17/ AV-18	On/Off valve with extension / knob handle -Fits all burner systems	50. ⁰⁰
AV17-12/ AV18-12	Case of 12 - On/Off Valves	600. ⁰⁰

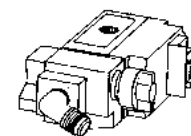

APK-11



SPK-26

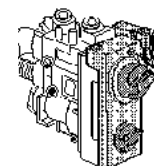

APK-15

SAFETY PILOT KITS (SPK'S), AUTOMATIC PILOT KITS (APK'S) & AUXILIARY ON/OFF VALVES (P = Propane Gas)



EPK-2V-TR



EPK-3V-TR

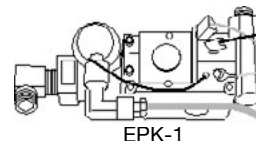

EPK-1

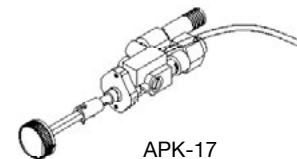

APK-17

REMOTE COMPATIBLE OPTIONS & ACCESSORIES

NO.	DESCRIPTION	PRICE
RR-1A	Basic ON/OFF Receiver/Transmitter Set	85. ⁰⁰
RR-2A	Deluxe ON/OFF Receiver/Transmitter Set	123. ⁰⁰
VR-1A	Basic Variable Receiver/Transmitter Set for 15 models	102. ⁰⁰
VR-2A	Deluxe Variable Receiver/Transmitter Set for 15 models	140. ⁰⁰
WS-1	Wall Switch, Cover and Wiring	47. ⁰⁰
WS-2	Wall Timer, Cover and Wiring	115. ⁰⁰
WS-3	Wall Switch, cover & wiring (15 & 17 product only)	58. ⁰⁰



WS-1



WS-2



WS-3



RR-1A



RR-2A



VR-1A



VR-2A

CONTROL MODEL NUMBER	BURNER SIZE		
	G4 & G45 STANDARD	G45-2 SEE-THRU	G4 SEE-THRU
SPK-20/SPK-26	12"-60"	16"-36"	12"-36"
SPK-20P/SPK-26P	12"-60"	16"-60"	12"-60"
APK-10 & APK-10P	12"-60"	16"-60"	12"-60"
APK-11	12"-30"	16"-18"	12"-18"
APK-11P	12"-60"	16"-36"	12"-36"
APK-15	12"-30"	16"-18"	12"-18"
APK-15P	12"-60"	16"-36"	12"-36"
APK-17	12"-30"	16"-24"	12"-18"
APK-17P	12"-60"	16"-60"	12"-60"
EPK-1	12"-30"	16"-18"	12"-18"
EPK-1P	12"-60"	16"-36"	12"-36"
EPK-2V	12"-36"	16"-30"	12"-30"
EPK-2VP	12"-60"	16"-42"	12"-42"
EPK-3V & EPK-3VP	12"-60"	16"-60"	12"-60"

A. G45 SERIES TRIPLE T BURNER SYSTEMS - LISTED

Style	Fireplace	No.	16"	18/20"	24"	30"	36"	42"	48"	60"
TRIPLE T BURNER SYSTEM†	Glass Standard	G45-GL-**	198. ⁰⁰ 20#	202. ⁰⁰ 22#	216. ⁰⁰ 28#	251. ⁰⁰ 31#	353. ⁰⁰ 45#	502. ⁰⁰ 70#	551. ⁰⁰ 80#	599. ⁰⁰ 100#
	Glass S/T	G45-2-GL-**	218. ⁰⁰ 35#	239. ⁰⁰ 40#	255. ⁰⁰ 50#	297. ⁰⁰ 65#	460. ⁰⁰ 70#	621. ⁰⁰ 80#	670. ⁰⁰ 95#	752. ⁰⁰ 120#
TRIPLE T OUTDOOR STAINLESS STEEL SYSTEM	Glass Standard	G45-GL-**-SS Natural Gas Only	264. ⁰⁰ 20#	274. ⁰⁰ 22#	293. ⁰⁰ 28#	336. ⁰⁰ 31#	445. ⁰⁰ 45#	599. ⁰⁰ 70#	656. ⁰⁰ 80#	717. ⁰⁰ 100#
	Glass S/T	G45-2-GL-**-SS Natural Gas Only	294. ⁰⁰ 35#	325. ⁰⁰ 40#	351. ⁰⁰ 50#	402. ⁰⁰ 65#	576. ⁰⁰ 70#	747. ⁰⁰ 80#	806. ⁰⁰ 95#	908. ⁰⁰ 120#
TRIPLE T OUTDOOR STAINLESS STEEL W/ ASSEMBLED VALVE	Glass Standard	G45-GL-**-N-SS OR G45-GL-**-P-SS	495. ⁰⁰ 22#	505. ⁰⁰ 24#	524. ⁰⁰ 30#	567. ⁰⁰ 33#	676. ⁰⁰ 47#	830. ⁰⁰ 72#	887. ⁰⁰ 82#	948. ⁰⁰ 102#
	Glass S/T	G45-2-GL-**-N-SS OR G45-2-GL-**-P-SS	525. ⁰⁰ 37#	556. ⁰⁰ 42#	582. ⁰⁰ 52#	633. ⁰⁰ 67#	807. ⁰⁰ 72#	978. ⁰⁰ 82#	1036. ⁰⁰ 97#	1139. ⁰⁰ 122#

G45 Series Triple T Burner Systems are LISTED and Include:
 • Triple T Burner • Connector Kit • Damper Clamp • Sand (Natural) or Vermiculite (Propane)

†Shipped for use with Natural Gas. Specify if for Propane Gas by adding a "P" to the model number (eg. G45-24P) and add \$142.⁰⁰ for required SPK-26.



G45-GL-**

B. PB SERIES GLASS BURNER SYSTEMS - LISTED

P Series Burner Systems Include:
 Pan Burner Assembly • Connector Kit • Damper Clamp, Sand (Natural) or Vermiculite (Propane)

Shipped for use with Natural Gas - Specify if for Propane Gas by adding a "P" to the model number (P-24P), and add \$142.⁰⁰ for required SPK-26.

Style	Fireplace	No.	16"	18"	20"	24"	30"	36"	42"
PAN BURNER	Burner Only (for glass)	PB-**	173. ⁰⁰ 16#	180. ⁰⁰ 18#	183. ⁰⁰ 19#	187. ⁰⁰ 20#	220. ⁰⁰ 22#	315. ⁰⁰ 25#	458. ⁰⁰ 28#

PB Series Burner

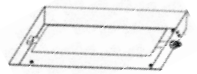

C. GLASS BURNERS ANSI CERTIFIED

Glass Burners Include: Certified Burner with Pre-assembled Control Valve & Regulator, Connector Kit, Damper Clamp, Sand (Natural) or Vermiculite (Propane)

Shipped for use with Natural Gas - Specify if for Propane Gas by adding a "P" to the model number (e.g. PB-24-15P).

Remote systems include basic Transmitter and Receiver

Approximate weight 18" = 24lbs, 24" 30lbs, 30" 33lbs

Style	Fireplace	No.	18"	24"	30"
BURNER W/ ASSEMBLED SPK (for glass)	Pan	PB-**A	373. ⁰⁰	380. ⁰⁰	414. ⁰⁰
	Standard	G45-GL-**A	395. ⁰⁰	407. ⁰⁰	444. ⁰⁰
	See-thru	G45-2-GL-**A	431. ⁰⁰	448. ⁰⁰	490. ⁰⁰
	Stainless Steel	G45-GL-**NA-SS	502. ⁰⁰	516. ⁰⁰	558. ⁰⁰
BURNER W/ STANDARD REMOTE (for glass)	Stainless Steel S/T	G45-2-GL-**NA-SS	574. ⁰⁰	602. ⁰⁰	653. ⁰⁰
	Pan	PB-**-11	670. ⁰⁰	677. ⁰⁰	711. ⁰⁰
	Standard	G45-GL-**-11	692. ⁰⁰	704. ⁰⁰	741. ⁰⁰
	See-thru	G45-2-GL-**-11	728. ⁰⁰	745. ⁰⁰	787. ⁰⁰
BURNER W/ VARIABLE REMOTE (for glass)	Stainless Steel	G45-GL-**-11-SS	764. ⁰⁰	781. ⁰⁰	826. ⁰⁰
	Stainless Steel S/T	G45-2-GL-**-11-SS	814. ⁰⁰	841. ⁰⁰	892. ⁰⁰
	Pan	PB-**-15	715. ⁰⁰	722. ⁰⁰	756. ⁰⁰
	Standard	G45-GL-**-15	737. ⁰⁰	749. ⁰⁰	786. ⁰⁰
BURNER W/ VARIABLE REMOTE (for glass)	See-thru	G45-2-GL-**-15	773. ⁰⁰	790. ⁰⁰	832. ⁰⁰
	Stainless Steel	G45-GL-**-15-SS	809. ⁰⁰	826. ⁰⁰	871. ⁰⁰
	Stainless Steel S/T	G45-2-GL-**-15-SS	859. ⁰⁰	886. ⁰⁰	937. ⁰⁰
	Pan	PB-**-17	607. ⁰⁰	614. ⁰⁰	648. ⁰⁰
BURNER W/ VARIABLE REMOTE (for glass)	Standard	G45-GL-**-17	629. ⁰⁰	641. ⁰⁰	678. ⁰⁰
	See Thru	G45-2-GL-**-17	665. ⁰⁰	682. ⁰⁰	724. ⁰⁰
	Stainless Steel	G45-GL-**-17-SS	701. ⁰⁰	718. ⁰⁰	763. ⁰⁰
	Stainless Steel S/T	G45-2-GL-**-17-SS	751. ⁰⁰	778. ⁰⁰	829. ⁰⁰
BURNER W/ ELECTRONIC REMOTE (for glass)	Pan	PB-**-01	775. ⁰⁰	782. ⁰⁰	816. ⁰⁰
	Standard	G45-GL-**-01	797. ⁰⁰	809. ⁰⁰	846. ⁰⁰
	See Thru	G45-2-GL-**-01	833. ⁰⁰	850. ⁰⁰	892. ⁰⁰
	Stainless Steel	G45-GL-**-01-SS	869. ⁰⁰	886. ⁰⁰	931. ⁰⁰
BURNER W/ ELECTRONIC REMOTE (for glass)	Stainless Steel S/T	G45-2-GL-**-01-SS	919. ⁰⁰	946. ⁰⁰	997. ⁰⁰

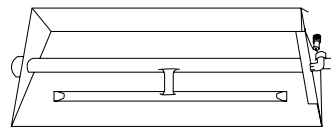

G45-GL Series Burner

D. G22-GL SERIES

G22-GL Series Burner

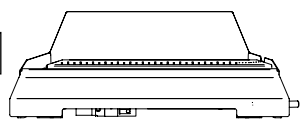

G22 Series Burner Systems Include:
 Stainless Steel Burner Pan • Hidden Controls • Connector Kit • Damper Clamp • Glass Front Panel(s)

Style	Fireplace	No.	18"	24"	30"
MATCH LIT (for glass)	Listed (Nat gas only) Stainless Steel	G22-GL-**	553. ⁰⁰	626. ⁰⁰	718. ⁰⁰
	Listed (Nat gas only) With Gold Trim	G22-GL-**-G	574. ⁰⁰	653. ⁰⁰	754. ⁰⁰
	See Thru Stainless Steel (Nat gas only)	G22-GL-2-**	718. ⁰⁰	822. ⁰⁰	934. ⁰⁰
	See Thru Rose Gold (Nat gas only)	G22-GL-2-**G	760. ⁰⁰	876. ⁰⁰	1006. ⁰⁰
REMOTE BURNER W/ HIDDEN CONTROLS (for glass)	Standard Stainless Steel	G22-GL-**-01	1034. ⁰⁰	1107. ⁰⁰	1199. ⁰⁰
	Standard With Rose Gold Trim	G22-GL-**-G-01	1055. ⁰⁰	1134. ⁰⁰	1235. ⁰⁰
	See Thru Stainless Steel	G22-GL-2-**-01	1199. ⁰⁰	1303. ⁰⁰	1415. ⁰⁰
	See Thru Rose Gold	G22-GL-2-**-01G	1241. ⁰⁰	1357. ⁰⁰	1487. ⁰⁰

FYRE GLASS

FYRE GLASS COLORS	5# Package \$ 41.00	7.5# Package \$ 61.00	10# Package \$ 77.00	NEW! 10# Jar \$ 81.00	NEW! 10# Jar 6-Pack \$ 471.00	40# Bucket \$ 310.00
AZURIA	GL-5-F	GL-7-F	GL-10-F	GL-10J-F	GL-10J-F-6	GL-40-F
AZURIA REFLECTIVE	GL-5-FR	GL-7-FR	GL-10-FR	GL-10J-FR	GL-10J-FR-6	GL-40-FR
BLACK	GL-5-B	GL-7-B	GL-10-B	GL-10J-B	GL-10J-B-6	GL-40-B
BLACK REFLECTIVE	GL-5-BR	GL-7-BR	GL-10-BR	GL-10J-BR	GL-10J-BR-6	GL-40-BR
BRONZE	GL-5-Z	GL-7-Z	GL-10-Z	GL-10J-Z	GL-10J-Z-6	GL-40-Z
BRONZE REFLECTIVE	GL-5-ZR	GL-7-ZR	GL-10-ZR	GL-10J-ZR	GL-10J-ZR-6	GL-40-ZR
CARIBBEAN BLUE	GL-5-N	GL-7-N	GL-10-N	GL-10J-N	GL-10J-N-6	GL-40-N
CARIBBEAN BLUE RFL	GL-5-NR	GL-7-NR	GL-10-NR	GL-10J-NR	GL-10J-NR-6	GL-40-NR
CLEAR	GL-5-C	GL-7-C	GL-10-C	GL-10J-C	GL-10J-C-6	GL-40-C
COPPER REFLECTIVE	GL-5-QR	GL-7-QR	GL-10-QR	GL-10J-QR	GL-10J-QR-6	GL-40-QR
EMERALD	GL-5-E	GL-7-E	GL-10-E	GL-10J-E	GL-10J-E-6	GL-40-E
EMERALD RFL	GL-5-ER	GL-7-ER	GL-10-ER	GL-10J-ER	GL-10J-ER-6	GL-40-ER
GOLD REFLECTIVE	GL-5-HR	GL-7-HR	GL-10-HR	GL-10J-HR	GL-10J-HR-6	GL-40-HR
SAPPHIRE	GL-5-S	GL-7-S	GL-10-S	GL-10J-S	GL-10J-S-6	GL-40-S
STAR FYRE	GL-5-W	GL-7-W	GL-10-W	GL-10J-W	GL-10J-W-6	GL-40-W



FYRE GEMS

FYRE GEM COLORS	5# Package \$ 35.00	7.5# Package \$ 51.00	10# Package \$ 68.00	NEW! 10# Jar \$ 72.00	NEW! 10# Jar 6-Pack \$ 420.00	40# Bucket \$ 262.00
BLACK GRANITE	GLG-5-B	GLG-7-B	GLG-10-B	GLG-10J-B	GLG-10J-B-6	GLG-40-B
BLACK PEARL	GLG-5-J	GLG-7-J	GLG-10-J	GLG-10J-J	GLG-10J-J-6	GLG-40-J
BLUE TOPAZ	GLG-5-T	GLG-7-T	GLG-10-T	GLG-10J-T	GLG-10J-T-6	GLG-40-T
CHAMPAGNE	GLG-5-D	GLG-7-D	GLG-10-D	GLG-10J-D	GLG-10J-D-6	GLG-40-D
CORAL REEF	GLG-5-R	GLG-7-R	GLG-10-R	GLG-10J-R	GLG-10J-R-6	GLG-40-R
DEEP AMBER	GLG-5-A	GLG-7-A	GLG-10-A	GLG-10J-A	GLG-10J-A-6	GLG-40-A
EMERALD	GLG-5-E	GLG-7-E	GLG-10-E	GLG-10J-E	GLG-10J-E-6	GLG-40-E
GLACIER	GLG-5-C	GLG-7-C	GLG-10-C	GLG-10J-C	GLG-10J-C-6	GLG-40-C
KOI	GLG-5-K	GLG-7-K	GLG-10-K	GLG-10J-K	GLG-10J-K-6	GLG-40-K
MINT	GLG-5-M	GLG-7-M	GLG-10-M	GLG-10J-M	GLG-10J-M-6	GLG-40-M
PLATINUM	GLG-5-P	GLG-7-P	GLG-10-P	GLG-10J-P	GLG-10J-P-6	GLG-40-P
SAPPHIRE	GLG-5-S	GLG-7-S	GLG-10-S	GLG-10J-S	GLG-10J-S-6	GLG-40-S



DIAMOND NUGGETS

DIAMOND NUGGETS COLORS	5# Package \$ 41.00	7.5# Package \$ 61.00	10# Package \$ 77.00	NEW! 10# Jar \$ 81.00	NEW! 10# Jar 6-Pack \$ 471.00	40# Bucket \$ 310.00
CLEAR	GLD-5-C	GLD-7-C	GLD-10-C	GLD-10J-C	GLD-10J-C-6	GLD-40-C
STEEL BLUE	GLD-5-SB	GLD-7-SB	GLD-10-SB	GLD-10J-SB	GLD-10J-SB-6	GLD-40-SB
ROSÉ	GLD-5-R	GLD-7-R	GLD-10-R	GLD-10J-R	GLD-10J-R-6	GLD-40-R
PACIFIC BLUE	GLD-5-PB	GLD-7-PB	GLD-10-PB	GLD-10J-PB	GLD-10J-PB-6	GLD-40-PB
LAVENDER	GLD-5-L	GLD-7-L	GLD-10-L	GLD-10J-L	GLD-10J-L-6	GLD-40-L
EMERALD	GLD-5-E	GLD-7-E	GLD-10-E	GLD-10J-E	GLD-10J-E-6	GLD-40-E



A. G4 SERIES GLOWING EMBER BURNER SYSTEMS

Style	Fireplace	No.	12"	16"/19"	18/20"	24"	30"	36"*	42"*	48"*	60"*
GLOWING EMBER BURNER SYSTEM	Standard	G4-**	164. ⁰⁰ 23#	177. ⁰⁰ 24#	184. ⁰⁰ 25#	190. ⁰⁰ 29#	224. ⁰⁰ 35#	321. ⁰⁰ 51#	466. ⁰⁰ 82#	507. ⁰⁰ 92#	559. ⁰⁰ 128#
	See-thru	G4-2-**	235. ⁰⁰ 35#	248. ⁰⁰ 38#	271. ⁰⁰ 43#	296. ⁰⁰ 45#	343. ⁰⁰ 57#	507. ⁰⁰ 87#	665. ⁰⁰ 138#	711. ⁰⁰ 150#	795. ⁰⁰ 213#
GLOWING EMBER* BURNER SYSTEM	Standard	GX4-**			205. ⁰⁰ 29#	214. ⁰⁰ 34#	251. ⁰⁰ 41#				
	See-thru	GX4-2-**			311. ⁰⁰ 45#	341. ⁰⁰ 50#	393. ⁰⁰ 63#				

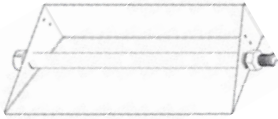

G4 Series Burner

G4 SERIES BURNER SYSTEMS are LISTED up to 30" and include:
 • Listed Glowing Ember Burner(s) • Custom Grate • Glowing Embers • Sand (natural) or Vermiculite(LP) • Flex Connector Kit • Burner Clips • Damper Clamp Shipped for use with Natural Gas - Specify if for Propane Gas by adding a "P" to the model number (G4-24P), and add \$142.⁰⁰ for required SPK-26 * with Heavy Duty Grate

B. G45 SERIES TRIPLE T BURNER SYSTEMS

Style	Fireplace	No.	16/19"	18/20"	24"	30"	36"*	42"*	48"*	60"*
TRIPLE T BURNER SYSTEM	Standard	G45-**	212. ⁰⁰ 25#	218. ⁰⁰ 27#	236. ⁰⁰ 31#	275. ⁰⁰ 37#	377. ⁰⁰ 54#	529. ⁰⁰ 82#	580. ⁰⁰ 97#	630. ⁰⁰ 120#
	See-Thru	G45-2-**	233. ⁰⁰ 40#	255. ⁰⁰ 45#	276. ⁰⁰ 59#	320. ⁰⁰ 75#	485. ⁰⁰ 82#	647. ⁰⁰ 90#	699. ⁰⁰ 105#	783. ⁰⁰ 140#
TRIPLE T HEAVY DUTY SYSTEM*	Heavy-Duty	GX45-**		240. ⁰⁰ 31#	260. ⁰⁰ 36#	301. ⁰⁰ 43#				
	See-Thru	GX45-2-**		295. ⁰⁰ 43#	321. ⁰⁰ 61#	372. ⁰⁰ 79#				
TRIPLE T OUTDOOR STAINLESS STEEL	Standard	G45-**-SS (Natural Gas only)	278. ⁰⁰ 25#	290. ⁰⁰ 27#	313. ⁰⁰ 31#	360. ⁰⁰ 37#	469. ⁰⁰ 56#	626. ⁰⁰ 87#	685. ⁰⁰ 97#	748. ⁰⁰ 120#
	See-thru	G45-2-**-SS (Natural Gas only)	309. ⁰⁰ 40#	341. ⁰⁰ 45#	372. ⁰⁰ 59#	425. ⁰⁰ 75#	601. ⁰⁰ 82#	773. ⁰⁰ 90#	835. ⁰⁰ 105#	939. ⁰⁰ 140#
	Standard w/ Assembled Valve	G45-**-N-SS† or G45-**-P-SS†	509. ⁰⁰ 27#	521. ⁰⁰ 29#	544. ⁰⁰ 33#	591. ⁰⁰ 39#	700. ⁰⁰ 58#	857. ⁰⁰ 89#	916. ⁰⁰ 99#	979. ⁰⁰ 122#
	See-thru w/ Assembled Valve	G45-2-**-N-SS† or G45-2-**-P-SS†	540. ⁰⁰ 42#	572. ⁰⁰ 47#	603. ⁰⁰ 61#	656. ⁰⁰ 77#	832. ⁰⁰ 84#	1004. ⁰⁰ 92#	1066. ⁰⁰ 107#	1170. ⁰⁰ 142#



G45 Series Burner

G45 Series Triple T Burner Systems are LISTED and Include:
 • Triple T Burner • Custom Grate • Glowing Embers • Sand (natural) or Vermiculite(LP) • Burner Clips • Flex Connector Kit • Damper Clamp • Shipped for use with Natural Gas. Specify if for Propane Gas by adding a "P" to the model number (eg. G45-24P) and add \$142.⁰⁰ for required SPK-26.
 † With Pre-assembled Valve * = Heavy Duty Grate

C. P SERIES FLAME PAN BURNER AND GLASS BURNER SYSTEMS



P Pan Burner

Style	Fireplace	No.	16"	18"	20"	24"	30"	36"	42"
PAN BURNER	Standard/See-thru	P-**	177. ⁰⁰ 16#	184. ⁰⁰ 18#	187. ⁰⁰ 18#	190. ⁰⁰ 20#	224. ⁰⁰ 22#	321. ⁰⁰ 25#	466. ⁰⁰ 28#

P Series Burner Systems Include:
 Pan Burner Assembly • Glowing Embers • Vermiculite • Connector Kit • Log Supports • Damper Clamp
 Shipped for use with Natural Gas - Specify if for Propane Gas by adding a "P" to the model number (P-24P), and add \$142.⁰⁰ for required SPK-26.

D. G45 ANSI CERTIFIED

Style	Fireplace	No.	16"	18/20"	24"	30"	36"*
ASSEMBLED BURNER W/ SPK	Standard Stainless	G45-**-A G45-**-NA-SS	406. ⁰⁰ 529. ⁰⁰ 26#	412. ⁰⁰ 541. ⁰⁰ 28#	428. ⁰⁰ 564. ⁰⁰ 32#	467. ⁰⁰ 611. ⁰⁰ 38#	558. ⁰⁰ 702. ⁰⁰ 53#
	See-thru Stainless	G45-2-**-A G45-2-**-NA-SS		449. ⁰⁰ 592. ⁰⁰ 45#	469. ⁰⁰ 623. ⁰⁰ 47#	513. ⁰⁰ 676. ⁰⁰ 60#	
ASSEMBLED BURNER W/ STANDARD REMOTE	Standard Stainless	G45-**-11 G45-**-11-SS	703. ⁰⁰ 769. ⁰⁰ 27#	709. ⁰⁰ 778. ⁰⁰ 29#	725. ⁰⁰ 802. ⁰⁰ 33#	764. ⁰⁰ 849. ⁰⁰ 39#	855. ⁰⁰ 940. ⁰⁰ 54#
	See-thru Stainless	G45-2-**-11 G45-2-**-11-SS		746. ⁰⁰ 832. ⁰⁰ 45#	766. ⁰⁰ 862. ⁰⁰ 52#	810. ⁰⁰ 915. ⁰⁰ 63#	
ASSEMBLED BURNER W/ VARIABLE REMOTE	Standard Stainless	G45-**-15 G45-**-15-SS	748. ⁰⁰ 814. ⁰⁰ 27#	754. ⁰⁰ 826. ⁰⁰ 29#	770. ⁰⁰ 847. ⁰⁰ 33#	809. ⁰⁰ 894. ⁰⁰ 39#	900. ⁰⁰ 985. ⁰⁰ 54#
	See-thru Stainless	G45-2-**-15 G45-2-**-15-SS		791. ⁰⁰ 877. ⁰⁰ 45#	811. ⁰⁰ 918. ⁰⁰ 52#	855. ⁰⁰ 960. ⁰⁰ 63#	
ASSEMBLED BURNER W/ VARIABLE REMOTE	Standard Stainless	G45-**-17 G45-**-17-SS	640. ⁰⁰ 706. ⁰⁰ 27#	646. ⁰⁰ 718. ⁰⁰ 29#	662. ⁰⁰ 739. ⁰⁰ 33#	701. ⁰⁰ 786. ⁰⁰ 39#	792. ⁰⁰ 877. ⁰⁰ 54#
	See-thru Stainless	G45-2-**-17 G45-2-**-17-SS		683. ⁰⁰ 769. ⁰⁰ 45#	703. ⁰⁰ 799. ⁰⁰ 52#	747. ⁰⁰ 852. ⁰⁰ 63#	
ASSEMBLED BURNER W/ ELECTRONIC REMOTE	Standard	G45-**-01 G45-**-01-SS	808. ⁰⁰ 874. ⁰⁰ 28#	814. ⁰⁰ 886. ⁰⁰ 31#	830. ⁰⁰ 907. ⁰⁰ 35#	869. ⁰⁰ 954. ⁰⁰ 41#	960. ⁰⁰ 1045. ⁰⁰ 56#
	See-thru	G45-2-**-01 G45-2-**-01-SS		851. ⁰⁰ 937. ⁰⁰ 47#	871. ⁰⁰ 967. ⁰⁰ 54#	915. ⁰⁰ 1020. ⁰⁰ 65#	

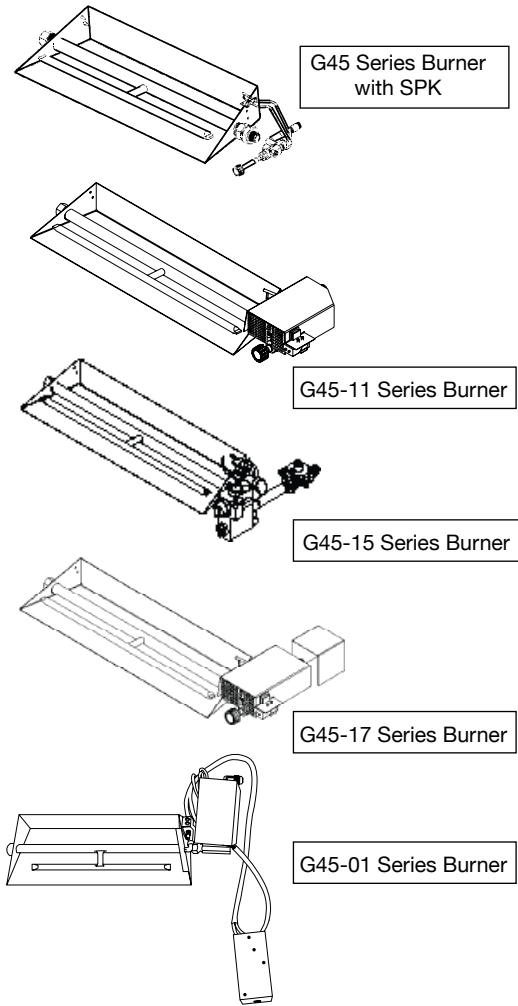

G45 Series Burner Systems are ANSI Certified & Include:
 Certified Burner with Pre-assembled Control Valve & Regulator • Custom Grate • Glowing Embers • Sand or Vermiculite
 • Connector Kit • Log Locators • Burner Clips • Damper Clamp
 Remote systems include basic Transmitter and Receiver.
 Shipped for use with natural gas. Specify if for propane gas by adding a "P" to the model number (e.g. G45-24-11P)

E. G46 SERIES ANSI CERTIFIED

Style	Fireplace	No.	18/20"	24"	30"
G46 W/SAFETY PILOT KIT	Standard	G46-**-	419. ⁰⁰ 20#	438. ⁰⁰ 23#	462. ⁰⁰ 28#
G46 W/REMOTE SYSTEM	Standard	G46-**-11	716. ⁰⁰ 21#	735. ⁰⁰ 24#	759. ⁰⁰ 28#
G46 W/ VARIABLE REMOTE SYSTEM	Standard	G46-**-15	761. ⁰⁰ 21#	780. ⁰⁰ 24#	804. ⁰⁰ 28#
G46 W/ VARIABLE REMOTE SYSTEM	Standard	G46-**-17	653. ⁰⁰ 21#	672. ⁰⁰ 24#	696. ⁰⁰ 28#
G46 W/ ELECTRONIC REMOTE SYSTEM	Standard	G46-**-01	821. ⁰⁰ 21#	840. ⁰⁰ 24#	864. ⁰⁰ 28#

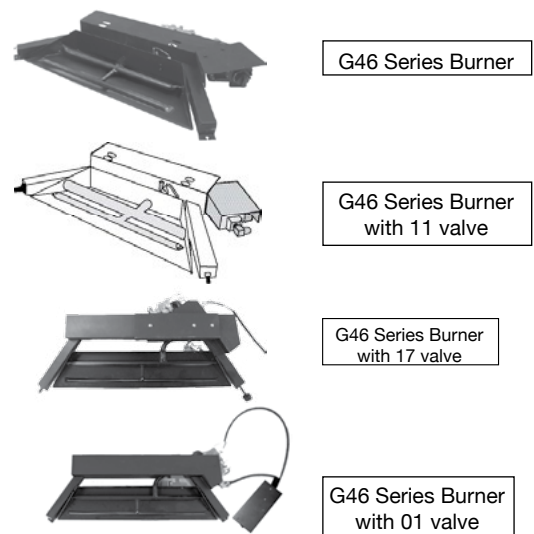

G46 Series Burner Systems are ANSI Certified & Include: Certified Burner with Pre-assembled Control Valve & Regulator • Custom Grate • Glowing Embers • Sand or Vermiculite • Log Locators • Connector Kit • Piezo ignitor • Damper Clamp
 Shipped for use w/ Natural Gas - specify if for Propane Gas by adding a "P" to the model number (eg. G46-24P).
 Remote systems include basic Transmitter and Receiver.

A. CHARRED SERIES GAS LOGS

Style	Fireplace	No.	16"	18/20"	19"	24"	30"	36"	42"	48"	60"	72"
1 CHARRED OAK	Standard	CHD-**	263. ⁰⁰ 28#/1	294. ⁰⁰ 46#/1	269. ⁰⁰ 31#/1	345. ⁰⁰ 62#/1	444. ⁰⁰ 78#/1					
	See-Thru	CHD-2-**	311. ⁰⁰ 30#/1	345. ⁰⁰ 48#/1	318. ⁰⁰ 34#/1	405. ⁰⁰ 62#/1	502. ⁰⁰ 84#/1					
1 BURNT RUSTIC OAK	Standard	HCHR-**	263. ⁰⁰ 28#/1	294. ⁰⁰ 46#/1		345. ⁰⁰ 62#/1	444. ⁰⁰ 80#/1					
1 CHARRED SPLIT	Standard	CHS-**		318. ⁰⁰ 42#/1		367. ⁰⁰ 54#/1	469. ⁰⁰ 78#/1	606. ⁰⁰ 116#/2				
1 BURNT SPLIT OAK	Standard	HCHS-**		318. ⁰⁰ 42#/1		367. ⁰⁰ 54#/1	469. ⁰⁰ 69#/1					
1 CHARRED RUGGED SPLIT OAK	Standard	CHRRSO-**		338. ⁰⁰ 46#/1		384. ⁰⁰ 57#/1	478. ⁰⁰ 62#/1					
	See-Thru	CHRRSO-2-**		383. ⁰⁰ 48#/1		453. ⁰⁰ 59#/1	537. ⁰⁰ 74#/1					
1 CHARRED AMERICAN OAK	Standard	CHAO-**		368. ⁰⁰ 57#/1		420. ⁰⁰ 63#/1	524. ⁰⁰ 82#/2					
	See-Thru	CHAO-2-**		416. ⁰⁰ 62#/1		483. ⁰⁰ 77#/1	593. ⁰⁰ 95#/2					
1 CHARRED CEDAR	Standard	CHCR-**		365. ⁰⁰ 46#/1		417. ⁰⁰ 55#/1	513. ⁰⁰ 67#/1					
1 CHARRED RED OAK	Standard	CHRED-**		365. ⁰⁰ 46#/1		417. ⁰⁰ 57#/1	513. ⁰⁰ 64#/1					
1 CHARRED FOREST	Standard	CHF-**		342. ⁰⁰ 48#/1		396. ⁰⁰ 62#/1	495. ⁰⁰ 81#/1					
1 CHARRED NORTHERN	Standard	CHN-**		306. ⁰⁰ 48#/1		360. ⁰⁰ 62#/1	457. ⁰⁰ 76#/1					
1 CHARRED OAK STACK	Standard	CHDS-**		292. ⁰⁰ 39#/1		343. ⁰⁰ 43#/1	414. ⁰⁰ 45#/1					
2 CHARRED ROYAL ENGLISH OAK*	Standard	CHB-**		365. ⁰⁰ 52#/1		434. ⁰⁰ 83#/2	534. ⁰⁰ 111#/2	680. ⁰⁰ 141#/3	881. ⁰⁰ 169#/3			
	See-Thru	CHB-2-**		428. ⁰⁰ 52#/1		498. ⁰⁰ 83#/2	607. ⁰⁰ 111#/2	754. ⁰⁰ 141#/3	976. ⁰⁰ 169#/3			
2 BURNT HERITAGE OAK*	Standard	CHH-**		350. ⁰⁰ 50#/1		403. ⁰⁰ 72#/2	500. ⁰⁰ 104#/2					
2 PIONEER OAK*	Standard	PN-**				422. ⁰⁰ 65#/2	530. ⁰⁰ 88#/2	662. ⁰⁰ 120#/3				
NEW CHARRED GRIZZLY OAK*	Standard	CHGO-**				424. ⁰⁰ 72#/2	570. ⁰⁰ 128#/2	705. ⁰⁰ 160#/3				
NEW CHARRED MAJESTIC OAK*	Standard	CHMJ**				497. ⁰⁰ 94#/2	616. ⁰⁰ 119#/2	746. ⁰⁰ 156#/3	873. ⁰⁰ 172#/3	1070. ⁰⁰ 300#/1	1275. ⁰⁰ 340#/1	1426. ⁰⁰ 430#/1

* = For use with Heavy Duty Grate (GX4)

Compatibility Key:

The following numbers in the Log Styles box designate the type of burners that are compatible with each Log Style.

1 Compatible with All Burner Styles (Listed on pages 12 & 13)
(G46 Burner Systems not available for See-Thru Log Styles)

2 Compatible with G4, GX4, G45, GX45 and "P" Series Burner Systems
(Non ANSI Certified)

B. DESIGNER SERIES GAS LOGS

Style	Fireplace	No.	12"	16"	18"	19"	20"	24"	30"	36"	42"	48"	60"
1 GOLDEN OAK DESIGNER PLUS	Standard	RDP-**	189. ⁰⁰ 18#/1	204. ⁰⁰ 24#/1	242. ⁰⁰ 41#/1	221. ⁰⁰ 40#/1	257. ⁰⁰ 46#/1	295. ⁰⁰ 61#/1	383. ⁰⁰ 75#/1	526. ⁰⁰ 120#/2	661. ⁰⁰ 187#/3	799. ⁰⁰ 222#/3	964. ⁰⁰ 299#/3
	See-Thru	RDP-2-**	189. ⁰⁰ 19#/1	225. ⁰⁰ 24#/1	268. ⁰⁰ 46#/1	249. ⁰⁰ 43#/1	286. ⁰⁰ 49#/1	348. ⁰⁰ 71#/1	430. ⁰⁰ 86#/1	625. ⁰⁰ 137#/3	681. ⁰⁰ 194#/3	850. ⁰⁰ 229#/3	1000. ⁰⁰ 305#/3
1 RUSTIC OAK DESIGNER	Standard	HRD-**		204. ⁰⁰ 24#/1	234. ⁰⁰ 41#/1			285. ⁰⁰ 61#/1	362. ⁰⁰ 94#/1	526. ⁰⁰ 128#/2	661. ⁰⁰ 187#/3		
1 FOREST OAK	Standard	FO-**			274. ⁰⁰ 50#/1			311. ⁰⁰ 71#/1	368. ⁰⁰ 85#/1				
1 AMERICAN OAK	Standard	AO-**			325. ⁰⁰ 49#/1			377. ⁰⁰ 58#/1	458. ⁰⁰ 77#/2				
	See-Thru	AO-2-**			356. ⁰⁰ 55#/1			416. ⁰⁰ 62#/1	517. ⁰⁰ 85#2				
1 CEDAR	Standard	CR-**			322. ⁰⁰ 44#/1			380. ⁰⁰ 62#/1	460. ⁰⁰ 64#/1				
1 RED OAK	Standard	RED-**			322. ⁰⁰ 48#/1			380. ⁰⁰ 61#/1	460. ⁰⁰ 65#/1				
1 SPLIT OAK	Standard	S-**			258. ⁰⁰ 44#/1		273. ⁰⁰ 48#/1	300. ⁰⁰ 65#/1	382. ⁰⁰ 78#/1				
1 SPLIT OAK DESIGNER PLUS	Standard	SDP-**			291. ⁰⁰ 46#/1		313. ⁰⁰ 49#/1	341. ⁰⁰ 67#/1	425. ⁰⁰ 78#/1	560. ⁰⁰ 127#/2			
	See-Thru	SDP-2-**			327. ⁰⁰ 46#/1		350. ⁰⁰ 49#/1	385. ⁰⁰ 70#/1	480. ⁰⁰ 83#/1	651. ⁰⁰ 129#/3			
1 RUGGED SPLIT OAK	Standard	RRSO-**			313. ⁰⁰ 48#/1			357. ⁰⁰ 61#/1	420. ⁰⁰ 65#/1				
	See-Thru	RRSO-2-**			349. ⁰⁰ 53#/1			398. ⁰⁰ 67#/1	464. ⁰⁰ 76#/1				
1 WOODSTACK	Standard	WS-**			348. ⁰⁰ 43#/1			396. ⁰⁰ 58#/1	485. ⁰⁰ 58#/1				
1 WOODLAND OAK	Standard	WO-**			235. ⁰⁰ 45#/1		242. ⁰⁰ 46#/1	274. ⁰⁰ 60#/1	340. ⁰⁰ 86#/1				
1 MOUNTAIN BIRCH	Standard	MBW-**			310. ⁰⁰ 45#/1			352. ⁰⁰ 72#/1	406. ⁰⁰ 85#/1				
	See-Thru	MBW-2-**			352. ⁰⁰ 53#/1			385. ⁰⁰ 80#/1	449. ⁰⁰ 91#/1				
1 WHITE BIRCH	Standard	W-**			267. ⁰⁰ 38#/1			299. ⁰⁰ 60#/1	350. ⁰⁰ 89#/1				
1 WESTERN CAMPFYRE	Standard	WCF-**			333. ⁰⁰ 45#/1			389. ⁰⁰ 55#/1	478. ⁰⁰ 72#/1				
1 SPLIT OAK (low set logs)	Standard	S6-**			256. ⁰⁰ 31#/1		272. ⁰⁰ 36#/1	298. ⁰⁰ 42#/1	343. ⁰⁰ 56#/1				
2 ROYAL ENGLISH OAK DESIGNER*	Standard	BD-*			330. ⁰⁰ 49#/1			396. ⁰⁰ 87#/2	480. ⁰⁰ 126#/2	605. ⁰⁰ 152#/3	762. ⁰⁰ 184#/3		

C. CLASSIC SERIES GAS LOGS

Style	Fireplace	No.	12"	16"	18"	19"	20"	24"	30"	36"	42"
1 GOLDEN OAK	Standard	R-**	130. ⁰⁰ 18#/1	141. ⁰⁰ 24#/1	156. ⁰⁰ 41#/1	147. ⁰⁰ 39#/1	163. ⁰⁰ 45#/1	172. ⁰⁰ 58#/1	207. ⁰⁰ 89#/1	321. ⁰⁰ 120#/2	479. ⁰⁰ 187#/3
	See-Thru	R-2-**	130. ⁰⁰ 19#/1	158. ⁰⁰ 27#/1	174. ⁰⁰ 46#/1	165. ⁰⁰ 42#/1	182. ⁰⁰ 48#/1	195. ⁰⁰ 68#/1	234. ⁰⁰ 97#/1	381. ⁰⁰ 137#/3	535. ⁰⁰ 194#/3
1 RUSTIC OAK	Standard	HR-**		141. ⁰⁰ 24#/1	156. ⁰⁰ 41#/1			172. ⁰⁰ 58#/1	207. ⁰⁰ 94#/1	321. ⁰⁰ 128#/2	479. ⁰⁰ 187#/3
1 RUGGED OAK	Standard	RRO-**			195. ⁰⁰ 48#/1			232. ⁰⁰ 61#/1	276. ⁰⁰ 65#/1		
1 POST OAK	Standard	PO-**			147. ⁰⁰ 45#/1		154. ⁰⁰ 46#/1	164. ⁰⁰ 60#/1	198. ⁰⁰ 86#/1		
2 ROYAL ENGLISH OAK*	Standard	B-**			211. ⁰⁰ 49#/1			260. ⁰⁰ 87#/2	312. ⁰⁰ 126#/2	400. ⁰⁰ 152#/3	531. ⁰⁰ 184#/3
2 COASTAL DRIFTWOOD	Standard	CDR-**			166. ⁰⁰ 44#/1			182. ⁰⁰ 56#/1	219. ⁰⁰ 57#/1	314. ⁰⁰ 81#/2	



TETRAS (GEO-TS-4)
2 Large H: 3 1/2" W: 4"
2 Small H: 3" W: 3"



CONES (GEO-CI-4)
2 Large H: 7" W: 3 1/2"
2 Small H: 5 1/2" W: 3"



OBELISKS (GEO-OT-2)
2 Large H: 9 1/2" W: 5"



SPHERES (GEO-SS-4)
2 Large D: 4 1/2"
2 Small D: 3"



PYRAMIDS (GEO-PI-4)
2 Large H: 3 3/4" W: 3 1/2"
2 Small H: 2 3/4" W: 2 1/2"



GEO DOMES (GEO-HT-4)
2 Large H: 4 1/2" W: 4 1/2"
2 Small H: 3 1/2" W: 3 1/2"



DIAMONDS (GEO-DS-4)
2 Large L: 10" W: 3 1/2"
2 Small L: 6 1/2" W: 2 1/2"



RIVER ROCK (STN-10)

Description	Color	Model No.	Quantity	Price	Model No.	Quantity	Price	Model No.	Quantity	Price
River Rock Fyre Stones	Assorted	STN-10	10 Assorted	107. ⁰⁰						
	Ivory	STN-10I								
	Slate	STN-10S								
	Terracotta	STN-10T								
Pyramids - 4 Sided	Ivory	GEO-PI-4	Two Large Two Small	54. ⁰⁰	GEO-PI-2L	Two Large	43. ⁰⁰	GEO-PI-2S	Two Small	25. ⁰⁰
	Slate	GEO-PS-4			GEO-PS-2L			GEO-PS-2S		
	Terracotta	GEO-PT-4			GEO-PT-2L			GEO-PT-2S		
Cones	Ivory	GEO-CI-4	Two Large Two Small	60. ⁰⁰	GEO-CI-2L	Two Large	45. ⁰⁰	GEO-CI-2S	Two Small	26. ⁰⁰
	Slate	GEO-CS-4			GEO-CS-2L			GEO-CS-2S		
	Terracotta	GEO-CT-4			GEO-CT-2L			GEO-CT-2S		
Spheres	Ivory	GEO-SI-4	Two Large Two Small	74. ⁰⁰	GEO-SI-2L	Two Large	57. ⁰⁰	GEO-SI-2S	Two Small	29. ⁰⁰
	Slate	GEO-SS-4			GEO-SS-2L			GEO-SS-2S		
	Terracotta	GEO-ST-4			GEO-ST-2L			GEO-ST-2S		
Geo Domes	Ivory	GEO-HI-4	Two Large Two Small	74. ⁰⁰	GEO-HI-2L	Two Large	57. ⁰⁰	GEO-HI-2S	Two Small	29. ⁰⁰
	Slate	GEO-HS-4			GEO-HS-2L			GEO-HS-2S		
	Terracotta	GEO-HT-4			GEO-HT-2L			GEO-HT-2S		
Geo Diamonds - 4 Sided	Ivory	GEO-DI-4	Two Large Two Small	74. ⁰⁰	GEO-DI-2L	Two Large	57. ⁰⁰	GEO-DI-2S	Two Small	29. ⁰⁰
	Slate	GEO-DS-4			GEO-DS-2L			GEO-DS-2S		
	Terracotta	GEO-DT-4			GEO-DT-2L			GEO-DT-2S		
Geo Tetra	Ivory	GEO-TI-4	Two Large Two Small	54. ⁰⁰	GEO-TI-2L	Two Large	43. ⁰⁰	GEO-TI-2S	Two Small	25. ⁰⁰
	Slate	GEO-TS-4			GEO-TS-2L			GEO-TS-2S		
	Terracotta	GEO-TT-4			GEO-TT-2L			GEO-TT-2S		
Obelisks	Ivory		N/A		GEO-OI-2	Two Large	66. ⁰⁰	N/A		
	Slate				GEO-OS-2					
	Terracotta				GEO-OT-2					



BDC-4 FOUR CHARRED BRANCHES BR-17 17" OAK BRANCH BR-29 9" OAK BRANCHES



SD-BONUS SPLIT LOGS SD-BONUS DESIGNER LOGS WCRD-1 WOODCHIP RING

DECORATIVE OAK TREE BRANCHES

NO.	DESCRIPTION	WT.	PRICE
BR-2	9" Oak Branches - 2 in box	3#	30. ⁰⁰
BR-17	17" Oak Branch	4#	37. ⁰⁰
BR-21	21" Oak Branch	11#	62. ⁰⁰
BDC-4	Four Charred Branches (Vacuum Packed)	11#	74. ⁰⁰

BONUS LOGS & CHARRED CHUNK

NO.	DESCRIPTION	WT.	PRICE
SD-BONUS	Special Designer Logs(2)	13#	72. ⁰⁰
SS-BONUS	Special Split Logs (2)	8#	78. ⁰⁰
CHC-01	Charred Series Chunk	2#	21. ⁰⁰
WCRD-1	Wood Chip Ring	3#	26. ⁰⁰

DECOR PACK & REFRESH KIT

NO.	DESCRIPTION	WT.	PRICE
DP-2	Includes 4 small size wood chips plus 3 small size Pine Cones (Vacuum Packed)	3#	51.00
DP-5	Ember Enhancing Decor Kit (Including Bryte Coals, Lava Coals, 2 Pine Cones and 2 Wood Chips)	10#	70.00
DP-7	Ember Enhancing Decor Kit (Including Bryte Coals, Lava Coals, 2 Pine Cones and 2 Wood Chips, 2 Acorns)	12#	77.00
HDK-1	Decor Kit- Includes 2 Acorns, 2 Pine Cones, and 4 Wood Chips		59.00
RK-1/ RK-1P	Refresh Kit includes: Ember Glow, Glue, Sand (Natural) or Vermiculite (LP), Bryte Coals, Lava Granules, & Acorns	25#	91.00
NEW AFK-1	Burner Affix Kit- Includes: Mounting Bracket Screw and Silicone		26.00

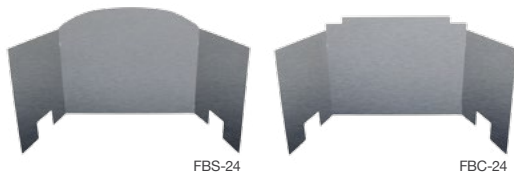

FYREBACKS - SATIN Stainless Steel
(Traditional FBS / Contemporary FBC)

NO.	DESCRIPTION	WT.	PRICE
FBS-18/FBC-18	18" Three Panel	10#	144.00
FBS-24/FBC-24	24" Three Panel	12#	164.00
FBS-30/FBC-30	30" Three Panel	14#	179.00
FBS-36/FBC-36	36" Three Panel	17#	199.00



FYREBACKS - POLISHED Stainless Steel
(Traditional Polished FBSP / Contemporary Polished FBCEP)

NO.	DESCRIPTION	WT.	PRICE
FBSP-18/FBCEP-18	18" Three Panel	10#	220.00
FBSP-24/FBCEP-24	24" Three Panel	12#	245.00
FBSP-30/FBCEP-30	30" Three Panel	14#	265.00
FBSP-36/FBCEP-36	36" Three Panel	17#	310.00



FYREBACKS - BLACK PORCELAIN
(Traditional FBSB / Contemporary FBCEB)

NO.	DESCRIPTION	WT.	PRICE
FBSB-18/FBCEB-18	18" Three Panel	10#	220.00
FBSB-24/FBCEB-24	24" Three Panel	12#	245.00
FBSB-30/FBCEB-30	30" Three Panel	14#	265.00
FBSB-36/FBCEB-36	36" Three Panel	17#	310.00



FYREBACKS - ROSE GOLD
(Traditional FBSG / Contemporary FBCEG)

NO.	DESCRIPTION	WT.	PRICE
FBSG-18/FBCEG-18	18" Three Panel	10#	414.00
FBSG-24/FBCEG-24	24" Three Panel	12#	449.00
FBSG-30/FBCEG-30	30" Three Panel	14#	489.00
FBSG-36/FBCEG-36	36" Three Panel	17#	550.00



WOOD CHIPS & ACORNS (VACUUM PACKED)

NO.	DESCRIPTION	WT.	PRICE
WC-6	6 Wood Chips	3#	43.00
WC-6-12	Case of 12 WC-6	34#	516.00
WCH-6	6 Charred Wood Chips	3#	49.00
WCH-6-12	Case of 12 WCH-6	35#	588.00
AC-6	6 Acorns	3#	31.00
AC-6-12	Case of 12 AC-6	35#	372.00



CERAMIC PINE CONES (VACUUM PACKED)

NO.	DESCRIPTION	WT.	PRICE
PC-4	4 assorted sizes Designer Pine Cones	4#	34.00
PC4-12	Designer, Case of 12	45#	408.00
PCW-4	Wilderness Pine Cone - 4 pc. Single Pack	4#	34.00
PCW4-12	Wilderness Case of 12	43#	408.00



EMBER GLOW

NO.	DESCRIPTION	WT.	PRICE
EM-1	Single Pack	6oz.	20. ⁰⁰
EM1-12	Case of 12	5#	240. ⁰⁰
EM-1S	Super Embers (Includes Bryte Coal)	7oz.	34. ⁰⁰
EM-11	Bryte Coals	2oz.	18. ⁰⁰

VERMICULITE GRANULES & SELECT WHITE SAND

NO.	DESCRIPTION	WT.	PRICE
LF-15	Vermiculite Granules	1.5#	22. ⁰⁰
LF-15-12	Case of 12	18#	264. ⁰⁰
CS-10	Select White Sand	10#	19. ⁰⁰
CS-10-6	Case of 6	66#	114. ⁰⁰



LAVA-FYRE COALS & GRANULES

NO.	DESCRIPTION	WT.	PRICE
LF-5	Lava-Fyre Granules	5#	16. ⁰⁰
LF5-12	Case of 12	68#	192. ⁰⁰
LF-10	Lava-Fyre Granules	10#	27. ⁰⁰
LF10-6	Case of 6	63#	162. ⁰⁰
LFC-10	Lava-Fyre Coals	10#	32. ⁰⁰
LFC-10-6	Case of 6	66#	192. ⁰⁰

VOLCANIC STONE

NO.	DESCRIPTION	WT.	PRICE
VS-3	Lava-Fyre Volcanic Stone in Poly Bag	3#	20. ⁰⁰
VS-3-12	12 Poly Bags of VS-3 in box	30#	240. ⁰⁰
VS-12	Assorted Stones in box	12#	42. ⁰⁰
VS-25	Assorted Stones in box	25#	70. ⁰⁰



WCEC-1 DESIGNER VALVE COVER WDCD-1 WOOD CHUNK DECOR COVER PCDC-1 PINE CONE DECOR COVER CHEC-1 CHARRED VALVE COVER
Hides remote receiver or crackler. Hides remote receiver or crackler.



GL-1 ADHESIVE GLUE

CRACKLER & COVERS (Vacuum Packed)

NO.	DESCRIPTION	WT.	PRICE
PCC-1	Pine Cone Crackler Complete with cover	4#	110. ⁰⁰
WCC-1	Wood Chip Crackler Complete with cover	4#	110. ⁰⁰
WDCD-1	Wood Chunk Decorative Cover	2#	32. ⁰⁰
PCDC-1	Pine Cone Decorative Cover	2#	32. ⁰⁰
WCEC-1	Valve Cover, Designer	7#	42. ⁰⁰
CHEC-1	Valve Cover, Charred	7#	42. ⁰⁰

FIRE PLACE GLUE

NO.	DESCRIPTION	WT.	PRICE
GL-1	Adhesive Glue	2oz.	18. ⁰⁰
GL1-12	Case of 12	5#	216. ⁰⁰



LOG LIGHTERS WITHOUT VALVES

NO.	DESCRIPTION	PRICE
LG-1	Rigid Single Gas log lighter	39. ⁰⁰
LG1-12	Case of 12 Gas log lighters	468. ⁰⁰
LL-1	Gasaver Single Gas log lighter	46. ⁰⁰
LL-1-12	Case of 12 Gas log lighters	552. ⁰⁰
LC-1	14" Cast Iron Gas log lighter	66. ⁰⁰
LC-1-12	Case of 12 LC-1 Gas log lighters	792. ⁰⁰



FENDERS (For all Gas log Sets)

NO.	DESCRIPTION	18"	24"	30"
FF-04-**	Fender Cast Iron	47. ⁰⁰	53. ⁰⁰	65. ⁰⁰